



# WOODEN EXERCISE POOL



**Model: SwimMaster™ Counter Current**

# INTRODUCTION

A video is available on our wooden pools website [www.woodenpools.net](http://www.woodenpools.net), the film shows a project from start to finish and is an informative guide to compliment this book. For detailed instructions please primarily use this book. You are advised to watch the entire video and read the whole book before starting your project.

In the event of any problems please contact your dealer immediately. Warranty claims may be affected if there is a delay in reporting a problem or if these instructions have not been followed.

## Recommendations for storage after delivery

- Do not store the timber in direct sunlight or under a dark cover as this may cause distortion which will make installation extremely difficult.
- Assemble the structure as soon as possible after receipt.
- Assemble the structure in one go, preferably in the morning while temperatures are cool.
- If a timber product must be stored, then use a cool well-ventilated place, sheltered from the rain and sun.
- Components that are damaged cracked or distorted due to incorrect storage and/or handling will not be covered by the warranty.
- Please ensure the liner is stored in a warm environment before installation.

In the pre-assembly period wood is sensitive to variations in temperature and humidity. It is therefore necessary that you take precautions immediately after delivery.

Wood is a living material and once cut the appearance of cracks, slight movements or changes in colour are normal and the planks (except in extreme circumstances) do not need replacing. The planks will have been recently treated and may be delivered still moist.

In the case of rapid temperature change these planks can dry very quickly and lose one or two millimetres of height. This might give the impression that the planks are lifting while they are actually shrinking. Whilst in cooler wet conditions the wood may expand back to its original size. This is completely normal.

**Please note; some of the images in this installation manual may be from another type of pool and are being used for illustration purposes only.**

## TOOL LIST

- |                               |                                |                              |
|-------------------------------|--------------------------------|------------------------------|
| - Tape measure                | - Hack saw or 4" angle grinder | - Hammer                     |
| - Spirit level                | cutting disc                   | - Sharp chisel               |
| - Various digging and         | - Hand saw or chop saw         | - Sand paper                 |
| concreting tools              | (if available)                 | - 85mm hole cutter           |
| - Socket set                  | - Set Square                   | (light installation only)    |
| - Heavy mallets               | - Pencil                       | - Wet and dry vacuum cleaner |
| - Cordless drill driver       | - Sharp Scissors               | - Decking oil and brush      |
| - Selection of driver bits    | - Hand-held screw driver       | - Goggles/glasses            |
| - 3mm, 4mm and 5mm drill bits | - Sharp Knife                  | - Protective gloves          |
|                               | - Exterior wood glue           |                              |

# NATURAL TIMBER CHARACTERISTICS

Whilst we try and ensure that our timber products reach you in perfect condition, we must remember that we are dealing with a natural material and there are many characteristics which may arise.

These are completely normal and have no detrimental effect on the product. We also manufacture our products so that most characteristics are on the inside the product where you will not see them, or the plank may be reversible, so that it can be used either way around.



**Shake** appears like a series of splits. With a timber of this size you will always encounter some degree of this (usually on one side). This does not affect the strength of the product and you will find the shake opens in continued warm weather and then closes when the weather is wet and cooler or there is a lot of moisture in the air. We manufacture our pools so that most natural characteristics are on the inside of a product where it will not be seen.



**Pith** or core is the centre of the tree this is similar to the above and quite often found alongside each other. Most of this is typically machined to be on the inside of the product.



**Knots and Sap** are typically found in timber as shown. These are generally not an issue and can be beneficial by relieving stress points in timber. In some people's opinion, this adds character to the products. Sap can also be present and can be carefully scrapped off with an appropriate tool.



**Cupping** is mainly caused by the treatment of the timber. Where the timber has been kiln dried and then pressure treated it can cause cupping. Although we do limit this, the best way to counteract is as you build the walls of your product, have one plank with the growth rings facing one way and the next with the rings facing in the opposite direction (counter cupping).



This is only possible on square or rectangular products as the planks are reversible. On Octagonal pools if you have a problematic plank try it in another wall position to see where it will fit best.

**Please note we cannot accept returns for natural characteristics complaints (except in extreme circumstances, at supplier's discretion). This includes planks which may arrive damp or containing mould residue (this is not a lasting or detrimental factor). Any damage caused by poor handling or failure to follow instructions is also not covered by our returns or warranty procedures.**

### **SAFETY NOTICE**

Unless your filtration kit (filter, pump any optional heating) is housed within a secure waterproof filtration enclosure, it should be placed at least 2 metres away from a swimming pool, you may need to purchase additional pipe and fittings if a filtration enclosure is not being used.

It is important to ensure the electricity supply for the filter pump or any other electrical equipment, has a 30 mA RCD protection circuit and conforms to current electrical regulations.

**NEVER LEAVE CHILDREN UNATTENDED AROUND THE POOL WHEN COMPLETED OR ANY STAGE OF THE CONSTRUCTION.**

The pool is designed for domestic use. Running along the top shelving, diving or jumping in from the edge must not be allowed under any circumstances. The pool is not suitable for the addition of a diving board.

# PREPARING THE BASE

You will need either a flat and level pre-existing hard standing, or to create a solid base for your pool to stand on. We recommend a 150mm thickness concrete base with reinforcing mesh. However, if you are confident that the area where the hard standing for the pool is strong enough you can start building the structure. If you are unsure, consult a ground engineer as you may possibly need to modify an existing base. It is very important that the result on the concrete is smooth and level as water will always find a level and show if the pools structure is not level. Because this pool uses a strap system the user may want to put a thin screed inside the pool to hide the strap. This must be level and smooth as any imperfection in the floor will show through the floor of the liner.

Below is the recommended concrete base size to suit the Exercise Pool.

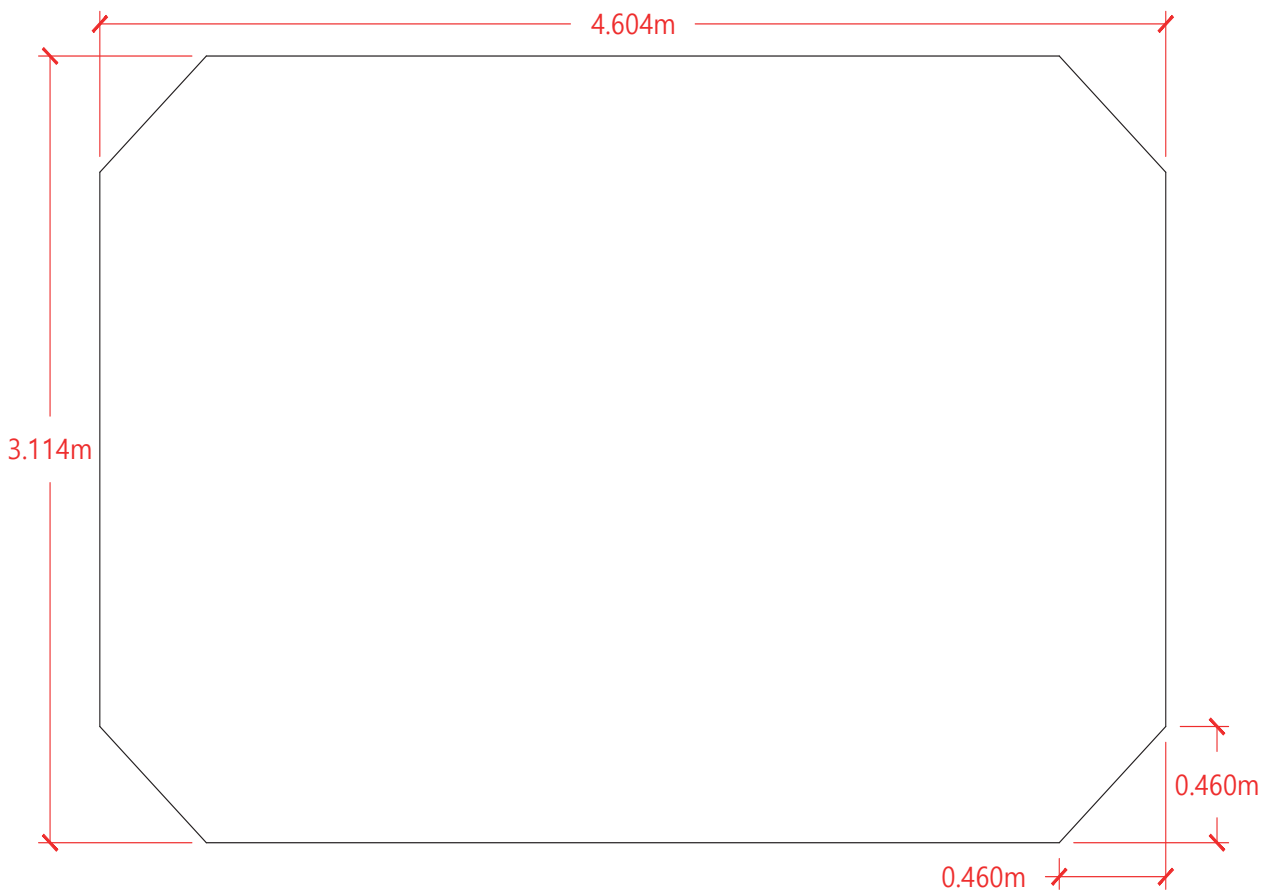

# TOTAL OR PARTIAL IN GROUND INSTALLATION

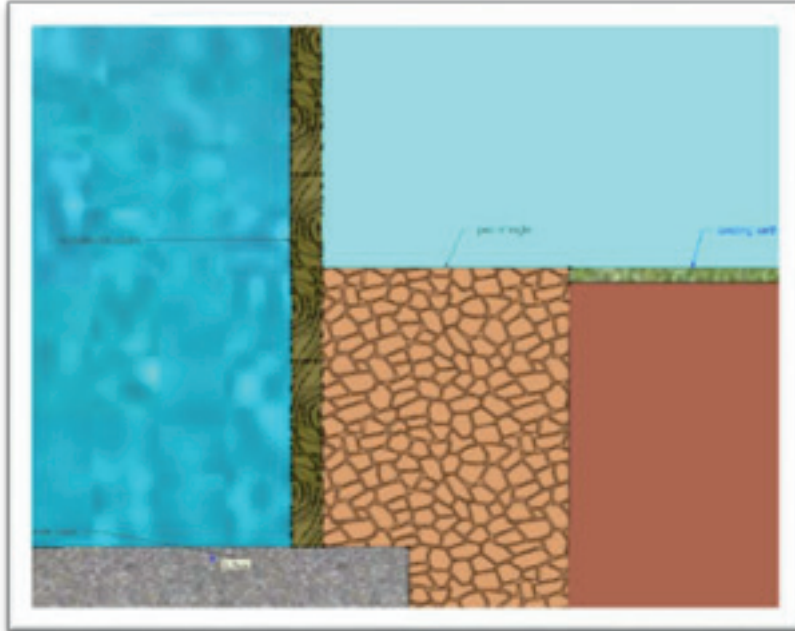

Plastica Wooden Pools can be installed above ground, partially in or fully in ground. However, if you do have your pool fully or partially in ground you will need to ensure that there is adequate drainage so that the timbers of your pool are not to be permanently submersed in water. Use an adequate amount of pea beach around the structure if possible with a run off to a soakaway or similar, so that water cannot build up around the structure and rot the timbers. If an adequate amount of drainage in the form of pea shingle or similar has not been used, this may affect the warranty. This product has been treated with ACQ which is child play friendly and is warranted against rot and insect attack (10 years on 44mm wood and 5 years on 27mm wood).

However, if this product is being installed completely or partially below ground level, you will need to install adequate drainage around the pool. We recommend 300-450mm width of pea shingle, all the way around the product. Never use a plastic membrane around the outside of product as this will accelerate any deterioration of a timber product.

The timbers are treated for ground contact only and are not to be submersed permanently in water.

Please also note that any modification to a wooden structure including drilling or cutting of a wall plank will void the warranty on any plank which is affected. As a precaution if you do require to modify a plank, we suggest that you treat the cut area with a good quality timber preservative if below ground level. Ensure any treatment does not come into contact with the liner.

# BUILDING THE TIMBER STRUCTURE

Please check the contents list and drawing to establish that all parts are present on delivery, you must report any damaged or missing items as soon as possible.

## TOP TIP

Lay out the wooden wall planks in an orderly fashion in the centre of the pool to be built. This will save you from having to climb in and out of the pool too much and could save you time and money

## UNDERSTAND THE WOODEN POOL WALL PROFILES

Bottom Half Plank



Standard Plank



Top Full Plank



Top Half Plank



The four different types of profile used for building the structure walls.



Once you are satisfied with your base for your wooden pool, locate the strap system and the long bottom half planks with the small slots machined out. Place the strap set under and within the slots of the long half planks.



Once you have located the strap system in position lay out all four bottom half planks as shown.

**Note:** Please refer to your laminate for exact layout. Configuration of bottom half planks can change between model.



*Knocking block*

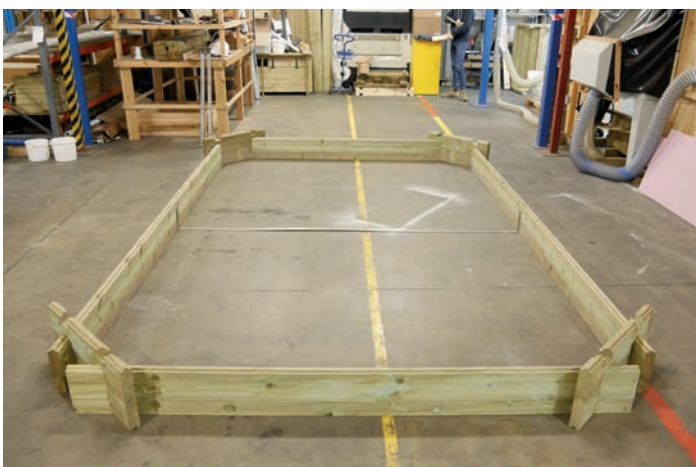

Next, use four standard corner planks to form the first layer/outline of your pool. Interlock the notches on the planks. From this point onwards, it is essential that you use the knocking blocks provided and do not use a mallet directly on the pool timbers as you will flatten the tongues and may damage the timbers, and making it extremely difficult to install the pool walls.





Start laying standard planks. Make sure you locate them well, before using a knocking block to hit the timber downwards until the tongue and groove joints are closed. When fitting the wall planks make sure you place the plank down evenly over both notches and locate the tongue and groove between each plank before you use the mallet to close the tongue and groove tightly together. This image shows a plank evenly being interlocked. It should go downward with the plank remaining horizontal. When installing longer planks get somebody to help you to do this. The best way to install longer planks is two people tapping the plank downward at each end and locating the plank properly before hitting it tightly together.



**X Stream Duo model only:** once you are two planks high in one of the corners of the pool, insert the bottom plank of the additional 63mm suction point planks. This should be the third plank from the ground. The next plank to go on top of this is the top plank of the 63mm suction point



Continue to lay the planks until you reach the third plank from the ground on the filtration wall and insert the low-level suction and return plank.

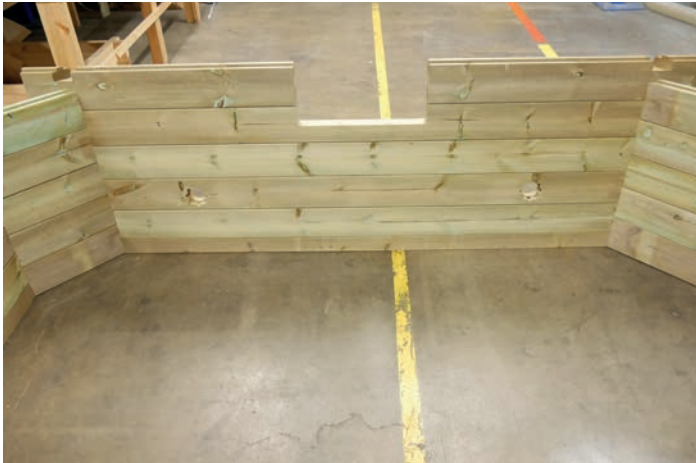

**X-Stream models only:** continue to lay standard planks until you are five planks from the ground including the half plank on the Filtration wall. This is where the bottom section of the X-Stream cut out should be positioned.



**X-stream models only:** continue laying the standard planks until you have reached the top of the X-Stream cut out, make sure the hole which is cut out of 3 planks, is tapped flush with a mallet.



If you have a standard exercise pool with a strap system continue to lay standard planks until you reach the lower skimmer plank. This is the second to last layer on the filtration wall. The recess cut out to accept the skimmer must be on the inside of the pool.



Place the skimmer into the bottom skimmer plank so it is ready to accept the upper skimmer plank.



When you are ready, carefully place the upper skimmer plank over the skimmer. This is one of the top full planks. Once you have located the notches and the tongue and groove between the planks, close it together by hitting it firmly with a mallet. Continue laying the rest of the top full planks.



Once the boards are closed together, using a spirit level on top of the skimmer, drill four holes 4mm diameter in the corners of the skimmer.



Screw the skimmer to the pool wall, using the 3.5mm x 20mm pan head screws provided as shown.



This image shows the skimmer screwed to the pool wall. Keep all other skimmer parts including the gaskets, somewhere safe to use later.



Once the skimmer is in place, stick one of the self-adhesive gaskets within the skimmer frame. Then partially fix a screw in each corner (do not screw in all the way). When doing this leave the crosshair of the screws in the North, East, South and West positions.



Once the skimmer is installed you can fit the top half planks which are the last of the wall planks.

## INSTALLING THE STRAP SYSTEM



Insert the upright bar between the timber wall and location hole of the strap system. Make sure it is vertical using a spirit level then drill a 10mm hole through the timber wall.



Try and ensure the drill bit comes in the middle or as close to the middle of the hole on the strap system.



Gently tap a m10 coach bolt through the wall from the inside of the pool. Be careful not to damage the thread on metal whilst inserting it as this will make it difficult to attach a nut. When this is tightened the bolt should be sitting flush against the strap system.



On the outside of the pool connect the Nyloc nut to the bolt and tighten ensuring the upright section is vertical with a spirit level.



Now install the top bolt on the main upright section ensuring it is vertical. You can then add the rest of the bolts and tighten with a nut.



There is no need to fix the very top part of the telescopic upright section at this point.

# INSTALLING WOODEN TOP BEAM SUPPORTS AND VERTICAL SUPPORTS

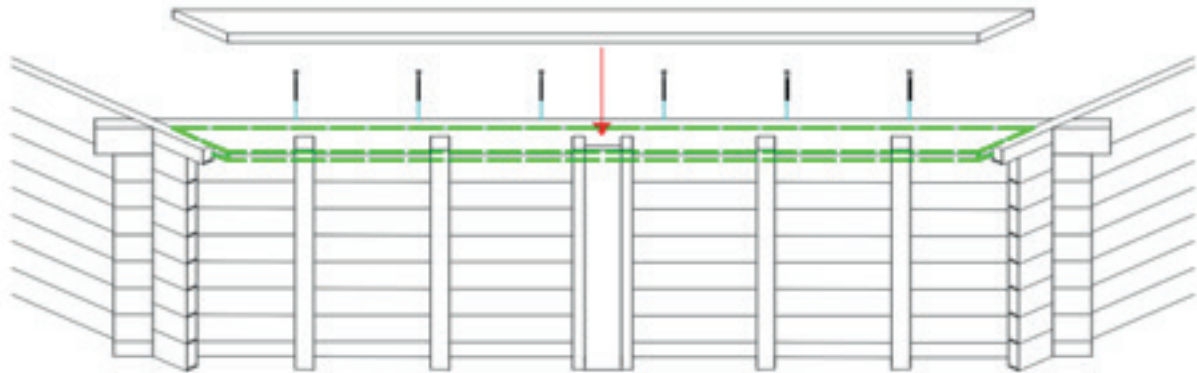

Please note: that the long walls of the exercise pool have a main top beam timber fitted edgeways, using 150mm green index screws; the top beam is fixed in place. All vertical supports on the long wall need to be cut to length, they sit just under the main top beam. Some of the following images may not show the ring beam and are for illustration purposes only.



Position the long wall top beam support, flush with the top edge of the pool. There is a top beam support for each long wall. It is a good idea to clamp it in place before screwing in the fixings.



Fix the top support beam in place using the 150mm index screws. Ensure the head of the screw is driven just below the surface of the timber.





Once the top beam support has been installed you can extend the strap system upright leave to the top of the wall underneath the timber support beam and drill a 10mm hole ready to connect a bolt.



Insert a 100mm coach bolt through the hole from the inside of the pool.



Connect the nut supplied to the bolt and tighten.



On the long walls of the exercise pool cut the vertical support planks so they fit underneath the timber support beam. Mark out the positions as per the plan drawing.



Leave the two supports which cover the strap system, these can be fixed in place after the top shelving has been installed. For the other vertical supports, fix two 100mm screws through the support timber into the vertical support.

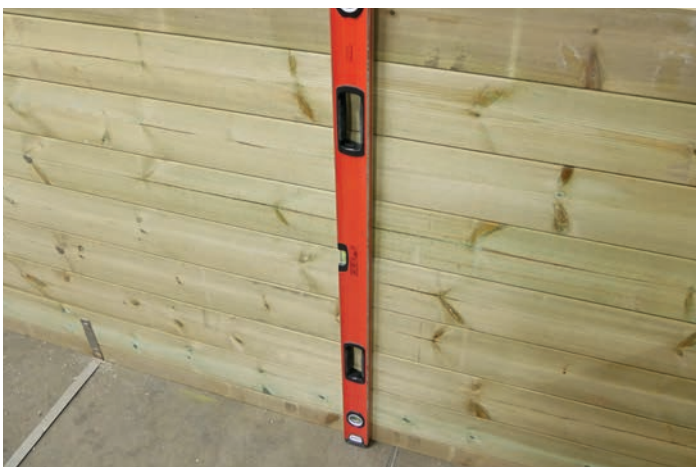

On the inside of the pool mark a vertical line using a spirit level in the centre position of the vertical supports.



Fix a 100mm screw in the top and bottom plank of the pool wall into the vertical support, ensuring it remains vertical with a spirit level. Then insert a screw into every plank of the pool wall securing the vertical support in place.



Continue to work your way around the pool installing the vertical supports as per their positions on the plan drawing.

# INSTALLING TOP SHELVING BRACKETS



Use the Wooden Pool Layout drawing to mark your centre lines for the top shelving brackets. You will need to use a square and a level to make sure that the Top Shelving Brackets are installed correctly and flush with the top of the pool.



Fix the Top Shelving Brackets in place using the 5 x 100mm screws; two per Top Shelving Bracket. Continue installing all Shelving Brackets, pay attention to positions i.e. where Top Shelving may join, as the centre of the Shelving Bracket needs to be at the centre of the joint in the Top shelving, or where you would like to position the Wooden External Ladder. Refer to the Wooden Pool Layout drawing for details.

It is useful to have someone hold the shelving bracket in the correct position whilst you fix it in place with two 100mm screws.

# INSTALLING TOP SHELVING



The top shelving which surrounds the pool comes with eight inner planks and eight outer planks (note: Westminster, Regent and Chelsea have joined sections for the long walls). The joins on the long wall should finish on the centre of a top shelving bracket or vertical support. When a section of top shelving joins another, stainless steel biscuits are slotted into a machined groove at the end of each plank these must be used at every join whether it is a straight or mitred join.



Take your time lining up the top shelving before drilling any holes or fixing any screws. This can be the longest part of the installation, as it is to be done as neatly as possible for best results. The inner planks are designed to overhang the liner-lock by approximately 20mm. There should also be a small gap between the inner and outer planks of approximately 4mm.



Once you are satisfied with the top shelving placed around the pool, you can mark out screw positions, where the top shelving rests on shelving brackets, in the eight corners of the pool and any vertical supports. The profile of our top shelving has been specially designed, so any fixings go through the flat areas of the timber. You must make sure that when you mark out screw positions the screws will not come into contact with the liner or Liner-lock. Any warranty claim for a mechanically damaged liner will not be covered.



There are two options for fixing with the kit supplied. Option one is 'Hidden Fixings' this is the most popular where no screws can be seen in the top shelving as the screws are hidden by wooden pellets. Option two is 'Exposed Fixings' where the screws are countersunk flush with the surface of the timber and can still be seen. There are two plugging drill bits supplied with your fixing kit these can be used for both applications 'Hidden Fixings' or 'Exposed Fixings'. The screws used are stainless steel 5 x 70mm. which are supplied.



For hidden fixings drill your holes deep enough, so that after a screw is inserted, a tapered wooden pellet can be lightly tapped in the hole until it is tight. You will notice that on the side of the drill bits supplied, there are a few depth gauge lines. Once you have established the correct depth stick to the same depth hole throughout the installation. For Exposed fixings simply use the drill bit to counter sink the screw flush with the timber.



Tap the tapered wooden pellets in the holes tightly with a hammer and let the glue dry.



Once the glue has dried, using a sharp wood chisel to clean off the excess wooden pellet is the best method. Use the chisel upside down and work in the direction of the grain in the timber. If your chisel is sharp enough you will be able to clean off the pellet to a smooth finish, without having to use sandpaper to finish off.



The finished result should be a top shelving where the pellets are smooth and flat. The pellets blend into the top shelving and can hardly be seen.



Work your way around the pool. Once you have finished, we recommend you use a quality decking oil to keep the Top Shelving looking its best.



Now you can fix the strap system upright through the top shelving to tie everything together. Using a 6mm wood bit, drill a straight hole through both the top beam support and top shelving.



Now you can insert two 100mm bolts down the holes and connect a nut once the thread has protruded through the plate connected to the strap system.





Connect the nuts which are supplied and tighten them with a ratchet spanner.

At this stage you can install the boxing in around the strap system, which consists of two vertical supports spaced apart by a metal brace cover. Make sure they are fitted with the strap system in the middle.



Carefully slide the metal brace cover between the vertical supports and fix in place with the screws supplied.

# INSTALLING THE LINER-LOCK



Liner-lock is a plastic extrusion that is used to secure the pool liner. This needs to be fitted to the inside of the pool around the entire perimeter. When cutting Liner-lock you either cut it at 22.5/67.5 degrees to fit the corners of the pool or 90 degrees, other than aesthetics it makes no difference, as when the liner and liner-lock wedge is installed you cannot see the liner-lock. You can use a chop saw, panel saw, or hack saw to do this. The key thing to make sure you do. Where the liner-lock joins, make sure it is lined up properly at the groove to accept the liner running continuously, without any misalignment. As you can see in this photo the join runs with the groove completely in line.



Pre-drill the Liner-lock every 300mm with a 3mm drill bit as this will ensure inserting the screws is much easier and prevent any injury from slipping with the drill, when you are starting the screw. Use the 3.5mm screws provided to fix the Liner-lock all the way around the pool. Where the strap system bolt is on the inside of the pool fix a screw either side of the bolt, to prevent the liner lock bowing over the bolt.

# FITTING INLETS/LOW-LEVEL SUCTION



When installing an Inlet or Low-Level suction (number of Inlets/Low level Suctions dependant on model) you will notice a flower shaped recess on the inside of the pool where these fittings are located.



Insert the back part of the fitting and screw it to the wall using the 3.5mm x 20mm screws provided as shown. Keep the other parts and gaskets somewhere safe to use later. Make sure you have screw holes in the 12 and 6 o'clock positions.



At this stage, you can carefully stick one gasket on to the face of the fitting as shown, ensuring you line up the holes correctly when applying the gasket. Insert one screw top and bottom (do not fully tighten), with the cross in the screws facing North, East, South and West. This makes it easier when having to find the screw heads underneath the liner.



# INSTALLING THE SWIMMASTER COUNTER CURRENT SYSTEM



The SwimMaster™ Counter Current System comes with a set of installation instructions. Please see the photos of how the SwimMaster™ unit should be positioned during the install.

See page 14 of the SwimMaster™ installation guide on how to fit the unit to your wooden pool, as illustrated below.

## 1. Installation for thin pool wall with liner (wood, sheet metal, plastic, etc.)

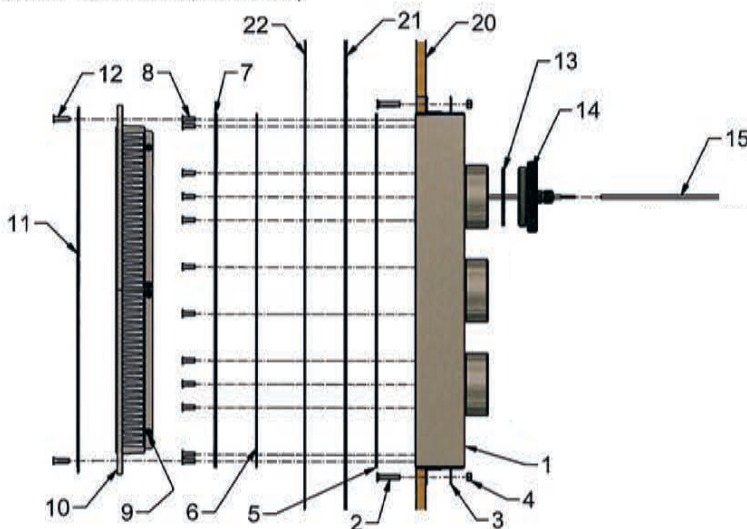

## ESPA Nadorsel Counter Current Pump Product Code: NCP300



## Counter Current Controllers Product Code: PINCC17



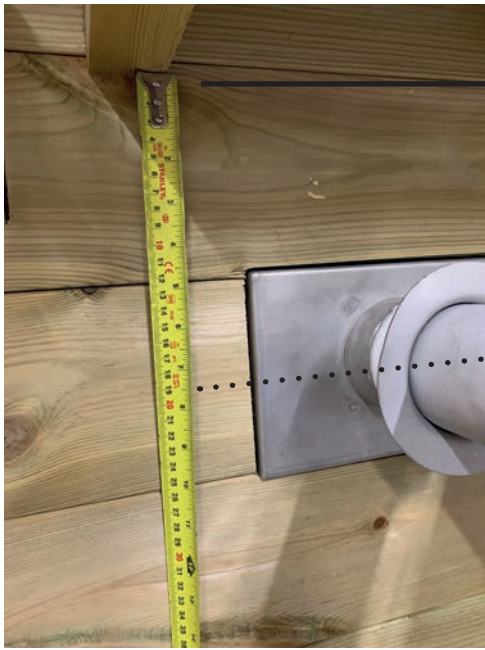

Water Level

Centre of the SwimMaster™

The SwimMaster™ unit should be positioned with the centre of the unit approximately 190mm from the running water level.



Place the SwimMaster™ counter current unit into the pre-cut hole. It may be necessary to even out the fitment by packing the bottom of the unit with a thin piece of wood or similar, from the outside of the pool.

Fix the SwimMaster™ unit in place using the fixings supplied with the unit.



Recommended plumbing configuration

# LAYING THE FELT UNDERLAY

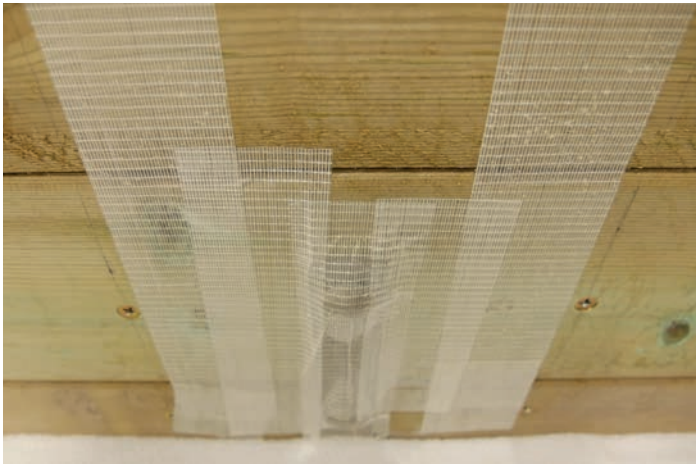

If there are any protruding fixings or sharp splinters inside the pool at this point, use a piece of underlay tape to cover up. Do not use any other type of tape than the underlay tape supplied.



Before laying the felt floor you may want to lay some self-levelling screed to the thickness of the stainless-steel strap. This will ensure you cannot see the strap once the liner is installed. It would also pay to use a product such as Rotabond to stick the strap to the floor prior to using a screed to ensure the strap stays flat. The other option is that you will see the strap but again stick it flat to a clean floor using the Rotabond.



Ensure the pool floor is completely clean from any debris or any other objects. Anything left in the pool can be unsightly for years to come and could even damage the liner. Lay the felt underlay out completely covering the pool floor and an overlap up the wall of about 10-20mm. Avoid joining edges together which have been cut on site. Always try and tape two machined edges together. Only use the tape provided, never use any other type of tape. Use a pair of sharp scissors to cut the felt, never use a knife. Make sure the felt does not overlap as this will show through the liner.



Finally, trim the perimeter of the pool by using the back edge of the scissors to score the felt between the pool floor and wall. This leaves a neat line in the felt that you can cut neatly with a sharp pair of scissors.

## FOAM WALL PROTECTION



Locate the foam and spray adhesive. Start in one of the corners of the pool. Spray the adhesive on about 2-3 metres of wall section. Start unrolling the foam from that corner of the pool pressing it firmly against the area of wall that you have just sprayed and work your way around the pool repeatedly.



Pay particular attention to pressing the foam firmly into the corners and under the liner-lock of the pool. Avoid getting adhesive on any fittings such as the inlets or skimmer.

Trim around the perimeter of the pool by running a sharp pair of scissors directly under the liner lock. Cut the foam away neatly around any pool fittings.

# INSTALLING THE LINER



It is essential that shoes are removed for the next stage. Hopefully you have read the Recommendations for Storage section at the front of this booklet and have kept your liner in a warm environment. If you haven't, we strongly recommend you do so, for a good period so that the liner feels relatively warm and supple. A cold liner is much harder to install, and you may not be able to remove creases in the liner. Before fitting make sure any fittings such as inlets skimmers and lights have gaskets in place and screws in the N, S, E, W positions as explained previously.



Unfold the liner and lay it to suit the shape of the floor. At one position on the wall of the liner, there is a welded seam. Ensure this doesn't run through with a skimmer. If it does, rotate the liner.

Once unfolded line up the floor corners of the liner with the floor corners of the pool structure.

**NOTE:** the pool liner will have been made smaller than the structure, and the weight of the water stretches it into position.



Starting at a corner, take one of the walls and feed it into the liner-lock. When you release it, the weight of the liner holds it in position.





Carefully work your way around the pool, paying attention to the corners to make sure they line up correctly.



Use your feet to gently push the corners of the pool liner into place.



If the liner is not quite lined up, you can unhook the liner and straighten it so that it is all lined up perfectly.



On larger pools use underlay tape to completely seal the fittings on the pool such as skimmers, inlets and lights. The idea is to make the pool structure as air tight as possible.



Using a vacuum cleaner with just the hose attached, peel back a small section of liner, and insert the hose as far down to the pool floor as possible. Make sure nothing can get stuck behind the liner. Attach as much liner back as possible into position around the hose. Then use the underlay tape to seal around the hose. You can now turn on the vacuum to help you.



Start removing any creases by systematically pushing them away from the centre of the pool floor towards the walls.

**If you have any main drains be very careful not to tread on them.**

Continue adjusting the liner and removing as many creases as possible.



When you are happy with the position of the liner you can install the liner-lock wedge. The wedge goes above the liner into the liner-lock channel. This locks the liner in place. Start in a corner working your way around the pool, pressing it firmly into place. When you reach a corner, measure it precisely and cut the liner-lock wedge to length, or alternatively you can cut a simple 'V' shape out of the back of the liner-Lock Wedge. Get somebody to cut it standing away from the liner to prevent any accidents or damage the liner. Carry on working your way around the pool cutting the liner-lock wedge to length as required.

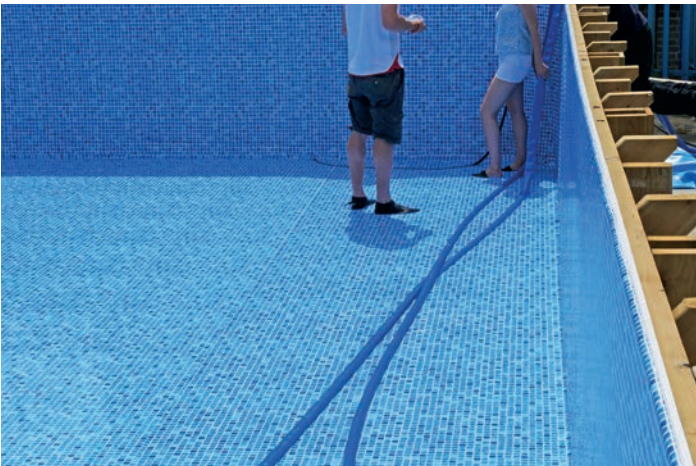

You can now start filling the pool with water.

Continue to push any creases out of the floor by sliding your foot from the middle of the floor towards the pool walls. Any stubborn minor creases that are left, may be packing creases, and should come out when the pool is filled and the water heated.



If you have main drains installed turn the water off after filling the pool with approximately 25mm of water.

Take extreme care whilst using a Stanley knife in a pool. Have somebody outside the pool who can hand you tools. Carefully feel for the head of the two screws under the liner. Remember you should have left the cross of the screw in the North, East South and West positions. Make a tiny cut in the "cross" of the screw head. Then gently tease the screw head through the small incision you have made.



You should have exposed the screw head, now carefully expose the other screw on the opposite side to the one you have just done.

Once you have exposed both screw heads you need the face plate for the drain. Carefully apply the gasket to the face plate.

Remove one of the screws you have exposed (using a hand-held screwdriver) and insert the screw through the face plate back into the hole and start to tighten screw. Then swing the face plate to the correct position and remove and insert the second screw.



You can now fit the rest of the screws as the face plate now gives the position of the remaining screws.

With a large circle gasket always insert one screw and then insert the screw opposite side, working your way around the gasket until all screws are tightened evenly.



Assuming the pipe work for the main drains has had a ball-valve connected and the main drain face plate secured, you can carefully remove the liner material within the gasket with a sharp knife.



Repeat the whole process for the second main drain.



Now you can screw the main drain cover plate into place.



Before the water level reaches 50mm below the low-level suction/inlets you need to make the pool water tight. Start by using the PTFE tape provided. Use plenty of tape on the socket nipples to create a good watertight seal.



Screw the socket nipple into the back of the low-level suction/inlets.



Ensure when you glue pipe work that you use the pipe cleaner supplied just before applying glue to both the fitting and pipe. It is sometimes a good idea to dry fit pipe work before gluing. This way you can be sure your layout is to your satisfaction before gluing.



Before cutting in the fittings on the liner plumb up any filtration/counter current pipework.

# INSTALLING LOW LEVEL SUCTIONS / INLETS



Next you need to cut in the low-level suction/inlet fittings. It's useful to have somebody outside the pool to hand you tools.

The pool needs to be filled to approximately 50mm below the fittings.

Feel for the screw heads with your fingers. Very carefully make an incision into the 'cross' of the screw head, remember the cross of the screw head is in the N, S, E, W position.

Once you have made the incisions, gently push the screw heads through the liner, ensuring the holes are as small as possible.



One gasket is on the fitting behind the liner, you now need to stick a gasket on the face plate ensuring the holes line up. Once you have done this, remove the top screw that is exposed. Insert the screw through the face plate back into the small hole you have made in the liner.

Now remove the bottom screw and let the face plate swing into position. You can now insert the second screw through the face plate and second screw hole you have made.



Always use a hand-held screw driver.

Gently tighten the screws and fit the other two screws.

Cut out the liner material within the face plate.



Finally screw in the eyeball/fixed grate fitting.



# X-STREAM COUNTER CURRENT SYSTEM



Again, before you start cutting in fittings for the X-stream unit the water level should be approximately 50mm below the screw heads which should be visible from behind the liner. Carefully expose the screw heads and four threaded lugs using the same method as when cutting in the inlets. Start with a small cross incision in the centre of the screw keeping it as small as possible but just enough, to stretch the liner over the screw/threaded lug.



Carefully attach the gasket to the faceplate ensuring all the holes line up. Then you can undo one of the corner screws and thread it back through the hole. This will help you locate the other three corners. Once you have all 4 screws in place tighten them by hand with a hand-held screwdriver.



Now you have the face plate in position, use a sharp pointy object like a screw to make a small hole for each machined screw to go through, each hole on the face plate.



Now fix the rest of the screws in position.



Try and tighten the face plate evenly all over. Once this has been done you can cut away the excess material inside of the gasket perimeter.



Now you can install the nozzles back in the order each component came off. Do not over tighten.



Once this has been done carefully install the front grill and grab bar using the four screw positions.

The X-Steam Duo model, has an extra inlet, fit the face plate and grill in the same way as the low-level inlets.

# INSTALLING THE SKIMMER

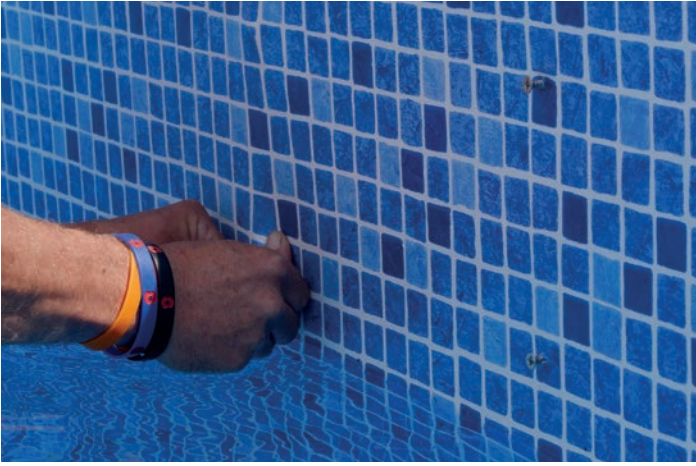

Installing the skimmer is the same method, as all the other pool fittings, except that the screws are in the four corners of the skimmer. When the water level is just below the skimmer carefully insert a small cut in the 'cross' of the screw heads, and gently push the screw head through the liner.



Apply the gasket carefully to the skimmer faceplate ensuring the holes line up.

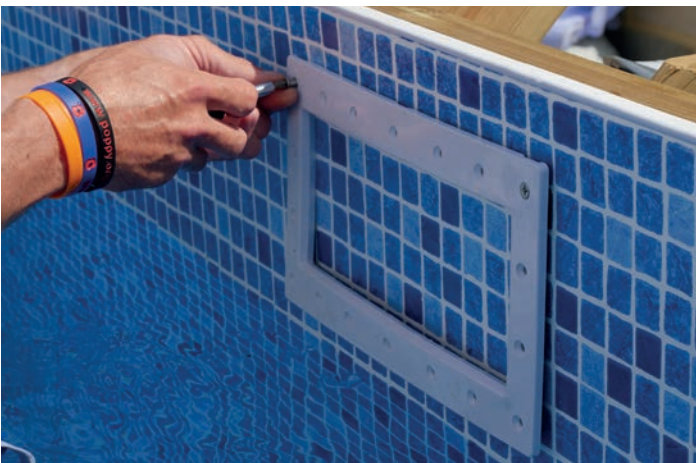

Undo a top corner screw and insert it through the faceplate, and back through the small hole you created.

Swing the skimmer up and do the same for the other top corner.

You can now undo the bottom two screws and screw them back through the faceplate into the small holes you made.

Gently tighten the four screws.

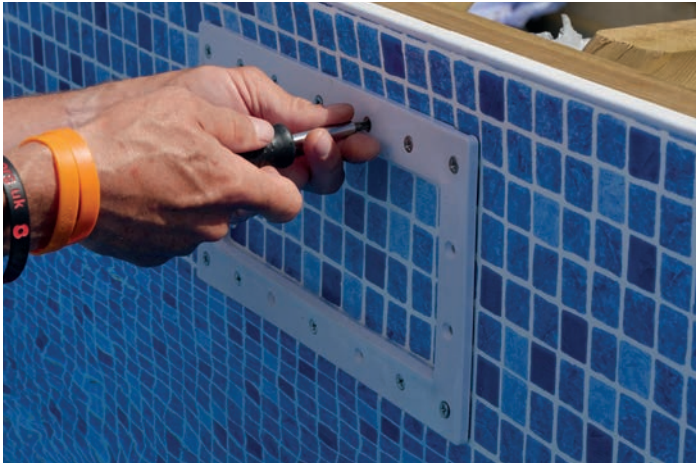

Now you can insert the rest of the screws. Try and do it systematically work from the middle of the skimmer, top and bottom. Working your way to the outer edges ensuring all the screws are tightened.



Carefully cut the liner from the inside of the skimmer with a sharp knife.



Once you are satisfied that the skimmer is sealed, press the cover plate into position

# INSTALLING END CAPPING CHANNEL



End Capping Channel is a u-shaped section of timber, which is used to cover the ends of the wall planks.

Cut this to length to suit the sixteen ends of wall section.

Use the drill bits supplied in the fixing kit to drill four pilot holes evenly on each end cap channel. Then fix in place using 5mm x 70mm screws provided.



Use the offcuts to fix a small piece of end capping channel to the top extended planks, with a 5mm x 70mm screw.

# INSTALLING THE PIPEWORK AND EQUIPMENT

To keep your swimming pool clear and hygienic you need to use a filtration system alongside chemicals, refer to the **Wooden Pool Operating and Maintenance Manual**. The simplistic view is water needs to go to the pump first via skimmer(s), low-level suction or main drains. It is then pushed through the filter which can contain either sand or glass media where the dirt is trapped. It can then return to the pool through the inlet fittings via a heater or heat pump (optional).

The valves and pipe work should be arranged so that it is impossible to have all the flow through the low-level suction. The high flow rate through one fitting could create an entrapment hazard which must be avoided.



Unpack the filter pump and position it before filling it with sand, it will be much easier to move whilst empty. Any electrical item must be at least 2 metres away from the pool unless enclosed by a filtration enclosure. The model of filter pump may vary depending on product purchased. Always read the manufacturer's instructions on how to assemble the product. Fill the filter with sand according to the instructions.

If you have an optional heater, assemble it after the filter pump according to the manufacturer's instructions.



The pipe work kit which is supplied is generous and there can be variations in fitting.

Run your pipe work as neatly as possible. Where possible install all pipe and fittings so they are resting on the ground. Trial fit all pipe and fittings without cleaner or glue, this "Dry Fitting" will save time in the long run and allow you to check work before committing to gluing.



Cut all pipework at 90 degrees, and remove any burs. Trial fit the pipe/s and fitting(s) "Dry Fit".

Use pipe cleaner on both pipe and fittings, this removes any dirt or grease on the fittings and helps with adhesion of the glue. Give both the pipe and fittings, a good coverage of glue and push together until set. On warm days, you may have to work fast, as the glue can set quickly.

# INVERTER HEAT PUMP

Up to eight times more efficient  
energy use than a standard  
electric heater

Average C.O.P. of five to one for every 1kW  
consumed based on only 15°C air temperature.  
Higher air temperatures will output more.

**ECO**  
Friendly

Find us on

The UK's Leading Independent  
Swimming Pool Manufacturer and Distributor

01424 857802    ✉ orders@plasticapools.net    🌐 www.plasticapools.net



# INSTALLING BRIO LED LIGHTS INTO A WOODEN POOL



Mark the position where you would like to install a light. Be aware of any vertical supports or other obstructions behind the wall. This is to ensure the back of the light fitting will not foul against anything. It is best to position the light approximately half way down the pool wall. Make sure the hole is within a single plank as shown.



Use an 85mm hole cutter to cut the hole for the light. Do not drill through the wall in one go from one side.



Go around the other side of the wall and drill from both sides to cut a neat hole without any splintering.



The fitting used as shown, uses a back nut in this sequence (shown), to tighten against the pool wall.

You will require one deck box kit per light (LED004).



Insert the fitting and tighten against the back nut on the other side of the wall.



Try and finish tightening the fitting in the position shown, with the screw holes at N, S, E, W.



If you have foam on the walls of your pool, you need to cut away approximately 30mm of foam so that the light can be screwed into place nicely without it being too tight against the liner. It is good to cut it with a chamfered edge, to achieve a nice finish when the liner is installed.



Stick the gasket in place lining up the screw holes.



Insert a screw top and bottom, do not fully tighten the screw and finish with the cross of the screws pointing N, S, E, W.



Apply plenty of PTFE to the conduit thread and screw it tightly into the threaded reducer.  
Glue the socket P/FT and threaded reducer together, use pipe cleaner first on both fittings and add a good layer of glue to each fitting.  
It is important to make the whole assembly watertight.



Establish how much pipe you want to use and cut it to length.



Glue a 50mm slip adaptor on the end of the piece of pipe you have just cut.



Now glue it into the back of the light fitting.



With the other end of the conduit apply plenty of PTFE tape to the thread and screw it into the bottom of the deck box.

The deck box must be mounted well above the water line of the swimming pool.

The light cable runs through the conduit into the deck box, where it can be linked to other Brio LED lights or into a power supply from a transformer. You must employ a qualified Electrician to carry out any electrical work on your wooden pool.



On the inside of the pool allow the water level to rise just below the light fitting which is now behind the liner. Carefully feel for the screws.

Using a sharp knife cut just the cross of the screw head.



Push the screw heads through the liner. Try and keep the holes as small as possible.

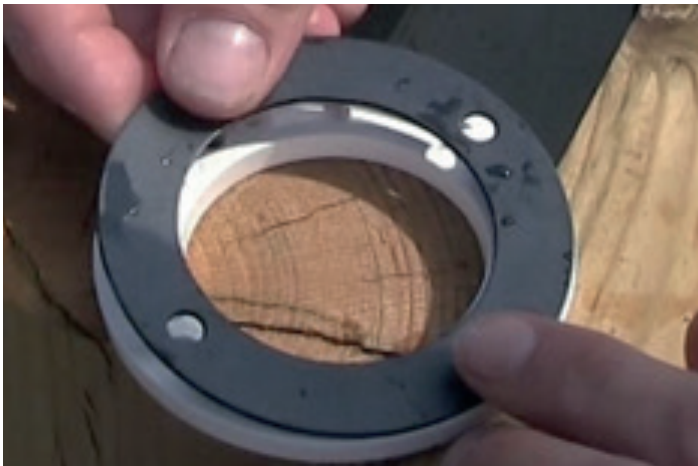

Line up the holes and stick the gasket to the face plate.



Undo the top screw and insert it back through the face plate, into the same hole it came from. Give the screw a couple of turns just to hold on to the face plate. When the face plate swings downward you can locate the bottom screw and carry out the same procedure.



You can now insert the other two screws and tighten all four screws using a hand-held screwdriver.

When the face plate and gasket are firmly fixed into position, carefully cut out the excess liner material in the middle of the light fitting.



Now the light fitting in the pool wall is exposed, you need to get the cable from the light up through the conduit into the deck box, where a connection can be made.

It is easier to thread the cable through the conduit by taping a zip tie or similar to the end, before pushing the cable through to the deck box.



Once you have secured the cable in the deck box you can screw the light fitting in place.



**Plastica**  
**EXERCISE**  
Wooden Swimming Pools

*Don't Forget....*

*to register your new  
Wooden Pool warranty  
online to validate it!*

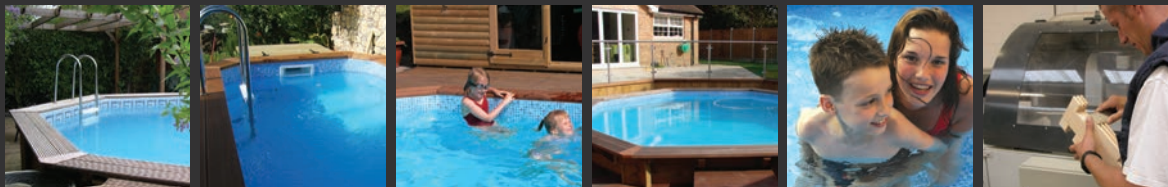

[www.woodenpools.net/warranty-registration](http://www.woodenpools.net/warranty-registration)

## WHAT ABOUT US?

Plastica is the UK's leading independent swimming pool manufacturer. Our state of the art 13,000 square metre factory is in St Leonards-on-Sea in East Sussex.

As well as wooden pools, we produce pool liners, solar, heat retention and debris covers, water treatments, stainless steel

reel systems, ladders and other accessories. We also sell a wide variety of wholesale products from established suppliers.

Our reputation for high quality, competitively priced products is based on our knowledge and understanding of the wet leisure market and our friendly, helpful staff.



**The UK's Leading Independent Swimming Pool Manufacturer and Distributor**

 [www.woodenpools.net](http://www.woodenpools.net)

 [sales@woodenpools.net](mailto:sales@woodenpools.net)

Find us on     





# Wooden Pool Warranty

Plastica give a **10 year** parts only warranty to the timber structure against wood rot and insect infestation

Timber Structure .....	10 years
Liner .....	5 years
Top Deck .....	1 year
Pump .....	1 year
Filter .....	1 year

### Terms of Warranty on Wooden Pool Structure:

The warranty duration on the wooden pool structure is 10 years on a pro-rata basis, reducing by 10% per annum. eg. after 3 years the warranty covers 70% of any valid claim.

The warranty covers the 44mm timber structure from insect attack and rotting. This applies to the damaged wall planks only, providing they are returned to our St Leonards factory at the consumers cost and risk. Any replacements will be arranged in accordance with the above warranty with free of charge delivery back to site (UK mainland only).

### Terms of Warranty:

1. We will need to see the original proof of purchase.
2. The pool must be installed in accordance with the installation instructions and remain in its original installation location.
3. Wood is a natural product and movement and discolouration can be expected. Plastica Ltd accept no liability for any such issues that may arise.
4. This warranty is between Plastica Ltd and the original purchaser and is not transferable.
5. Plastica Ltd accepts no liability for any consequential loss.

### Structure Warranty

0 to 12 months	100%
13 to 24 months	90%
25 to 36 months	80%
37 to 48 months	70%
49 to 60 months	60%
61 to 72 months	50%
73 to 84 months	40%
85 to 96 months	30%
97 to 108 months	20%
109 to 120 months	10%

### Liner Warranty

0 to 12 months	100%
13 to 24 months	80%
25 to 36 months	60%
37 to 48 months	40%
49 to 60 months	20%

# Notes

# Notes

# *Plastica*

The UK's Leading Independent Swimming Pool Manufacturer and Distributor



[www.plasticapools.net](http://www.plasticapools.net)

Find us on

