

CRANBOURNE STONE

EST 2004



SWIMMING POOL SURROUND & LANDSCAPE SPECIALISTS
TRADE SUPPLIER TO AWARD WINNING POOL & LANDSCAPE CONTRACTORS



「The Collection.24」



CRANBOURNE STONE

EST 2004

Cranbourne Stone, not just a stone supplier, but a swimming pool surround specialist with knowledge gained through decades of experience working in the swimming pool industry.

About us.

Having built prestigious swimming pools with the family business since the age of 17, Cranbourne Stone's MD Howard recognised the potential for higher quality pool surrounds, and just how much the industry was demanding them.

Using his 30+ years of experience, and with his wife Jo's vast knowledge of the swimming pool industry (which she has worked in since she was 18), together, Howard and Jo saw a great opportunity and formed Cranbourne Stone Ltd.

It's been 20 years since that day, and the Cranbourne Stone team has grown and with daughter Loren, son Max and nephews on board, it really is a family affair. From the early days of making precast (concrete) swimming pool copings to their modern bespoke cutting and profiling, the team has expanded their range of materials, products and services to cover all forms of swimming pool surrounds, pool tank tiles, mosaics and landscapes. They are now importing varieties of stone and porcelain from over ten different countries worldwide.

Compliments

In producing this brochure, we would like to thank our customers who kindly provided us with photos of their projects using our stone.

A&D Swimming Pools Ltd
Albatross Pools & Spas
Aqua King Pools

Bell Leisure Swimming Pools
Blue Cube Pools
Carl Vernon Swimming Pools
Chiswell Pools Limited
Cornwall Pools
Cresta Leisure Ltd
Darryl Young Swimming Pools
Esse Landscapes
Exquisite Landscapes

Fowler Swimming Pools Ltd
Giles Leisure Ltd
Hamilton Pools
Harlequin Swimming Pools
ISCA Pools and Hot Tubs
London Swimming Pool Company
Mermaid Swimming Pools
Precision Pools
Pure Pools

Rio Pool Construction Co Ltd
Rumsby Homes
RT Swimming Pool Services Limited
Second Nature Gardens Ltd
Simplex Swimming Pools
Spruce Pools
Urban Earth (S.W.LTD)
Wensum Pools & Hot Tubs
Whitewaters Ltd

20 years

Becoming a trade only supplier in June 2021 has allowed Cranbourne to support the trade, who have supported them over the years. Keeping the contractors happy and being as transparent as possible is of utmost importance. Using their knowledge of construction is a huge advantage when working with the pool installers and landscapers. Helping to achieve the pool and landscape of dreams, no matter how unique the idea.

Priding themselves on keeping up with the latest trends, the Cranbourne Stone team has carved themselves a niche in the stone industry, and 20 years later, their stellar reputation precedes them. The trends for swimming pool fittings are always changing, but thanks to their collective experience and amazing network of connections, they have always been able to keep up with them. Supplying through the Trade, enables Cranbourne to use their extensive knowledge to work in tune with the builders, turning a standard job into an exceptional project.

Bespoke and Unique Products and Services

Having created a name in the swimming pool industry, Howard and Jo have invested heavily over the years in state-of-the-art machinery. Starting with just a CNC 5 axis saw, they quickly grew the collection to create a fully equipped factory, complete with waterjets, 3 edge profiling machines, sandblasting and flaming machines. With this powerhouse of equipment at their disposal, they can now create anything and everything a client can imagine, and probably more.

Cranbourne Stone now produces and stocks the largest range of swimming pool surrounds in the UK. Understanding that no two projects are the same, Cranbourne also provides a bespoke site-template service, creating products that fit perfectly and look beautiful every time. Combining their focus on excellence with their technical expertise, hi-tech machinery and personal service, Cranbourne Stone thrives on a challenge and excels where others can only imagine.

Ethical Trading

Cranbourne Stone is proud to support the Ethical Trading Initiative, ensuring all of its products are produced in the most suitable working environment possible. It achieves this through the Ethical Trading initiative (ETI), which is an alliance of companies, non-governmental organisations and trade unions all dedicated to promoting ethical consumerism.

The ultimate goal is to make sure the working conditions of employees producing any product for the UK market meet or exceed international labour standards. We at Cranbourne Stone feel that everyone has the right to a fair and ethical working environment, and are dedicated to only sourcing materials from companies who support the Ethical Trading Initiative.



In memory of dear friends and family, Cranbourne Stone Ltd supports Ovarian Cancer Action.

Contents.

About Us	3	Deck Level Grilles	36	Indoor & Outdoor Porcelain		Useful Information	
Natural Stone – Introduction	5	Stonetech Deck Level Grilles	36	Awbridge Cream	76	Swimming Pool Coping options	96
Limestone		Stonetech 2x Slot Grille	38	Bridport Grey	68	Edge Profiles	97
Barton Ash	10	Stonetech Dished Grille	39	Buscot Ash	70	Roman End Bays & Corners	94
Crema Europa	14	Stonetech Slotted Grille	40	Buscot Crema	70	Pool Tank – Large Format Tiles	99
Downton	12	Stonetech Gallery	41	Buscot Pearl	70	Site Template / Survey	100
Fossil Pearl (Satin)	6	Porcelain 2x Slot Mono Grille	42	Cadiz Beige	62	Our in-house bespoke works	101
Fossil Pearl (Tumbled + Grip)	8	Porcelain Linear Grid Grille	42	Caulfield Green	64	Bespoke Masonry	102
Travertine		Natural Stone Bespoke		Concrete Beige	82	Landscapers & Designers	103
Travertine Tumbled + Unfilled	16	Deck Level Grilles	44	Concrete Grey	82	Laying guidelines for Porcelain	104
Sandstone		Deck Level Grille Gallery	46	Concrete White	82	Laying guidelines for Natural Stone	106
Cotswold Mint	18			Houghton Grey	74	Overlap Coping installation	
Danebury	26	Porcelain – Introduction	47	Meon Quartz	72	guidelines	108
Georgian Antique	22	20mm GRIP PORCELAIN		Portland Cream	66	Pack Types	109
Hawksworth	24	Bolzano	56	Roach Grey	86	Terms & Conditions	110
Leckford	28	Bruges Beige	57	Roach Pearl	86		
Raj	20	Burley Black	55	Sarum Grey	78		
York Stone		Carbis Sands	54	Studland Beige	67		
York	30	Ghent Grey	57	Travertine Bianco Cross	84		
Granite		Loretto Buff	58	Travertine Vein White	84		
Monxton Black	32	Lonato Grey	50	Waterford Cream	64		
Natural Stone Finishes	34	Namur Light	52	Wilton Beige	80		
		Namur Dark	52	Wood Porcelain			
		Rialto Crema	60	Ash Wood	88		
		Rialto Grigio	60	Oak Wood	88		
		Rockford Quartz	56	Exagres Extruded Porcelain	90–93		
		Sirmione	50	Porcelain Bespoke Pieces	95		
		Sorrento	58	Mosaics NEW	98		

Natural Stone

With natural stone being hand selected from the best, most consistent sources, you really are able to appreciate its' beauty. Differing in tonal variation and textures lends itself to helping you create a one of a kind, unique finish to every project.

SLIP RESISTANCE RATING:			
Potential For Slip	Pendulum Test Value (PTV)	Dry	Wet
High Slip Potential	0 – 24	1	A
Moderate Slip Potential	25 – 35	2	B
Low Slip Potential	36 +	3	C

Natural Stone
Limestone – Fossil Pearl (Satin)

A dense fossil limestone with warm beige and grey tones, combined with a sandblasted finish for slip resistance and sawn edges gives a wonderful contemporary look with low maintenance pool surround, landscape or internal project. Ideal for indoor and outdoor projects.



Tiles:

900 x 600 x 20mm

NB: if used externally, this must be laid on a solid concrete bed, with a fall.

Paving:

900 x 600 x 30mm

Swimming Pool Copings:

600 x 300 x 40mm

with full bullnose

600 x 300 x 30/ 50mm

with an over-lip

Step Treads:

600 x 450 x 40mm

with full bullnose

Standard items:

90° Square & 6" Radius Corners

4ft & 5ft Roman Ends are made to order

Cut to size and bespoke profile available.

Bespoke:

Free-form shaped copings & bespoke stone work are made to measure in-house.

Site template service available.

Natural stone varies in both colour and texture. The appearance of the stone will change when wet, enhancing the natural tones within the stone.



Natural Stone
Limestone – Fossil Pearl (Tumbled + Grip)

This very dense limestone with its beige/grey tones and wonderful fossil markings, has been tumbled and etched to create an elegantly aged and slip resistant stone, perfect for any indoor or outdoor swimming pool or landscaping project.

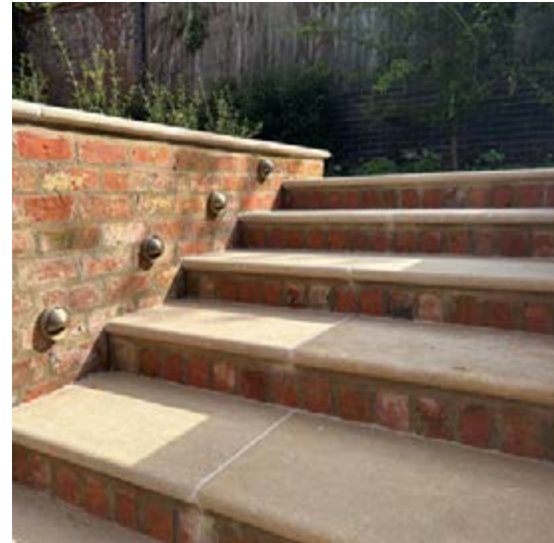

Tiles:

900 x 600 x 20mm
 NB: if used externally, this must be laid on a solid concrete bed with a fall.

Paving:

900 x 600 x 30mm
 600 x random length x 30mm

Swimming Pool Copings:

600 x 300 x 40mm
 with full bullnose

Step Treads:

600 x 450 x 40mm
 with full bullnose

Tumbled Setts:

200 x 100 x 40mm
 200 x 50 x 40mm
 200 x 100 x 30mm

Standard items:

90° Square & 6" Radius Corners
 4ft & 5ft Roman Ends are made to order
 Cut to size and bespoke profile available.

Bespoke:

Free-form shaped copings & bespoke stone work are made to measure in-house.
 Site template service available.
 Natural stone varies in both colour and texture.
 The appearance of the stone will change when wet, enhancing the natural tones within the stone.



Natural Stone

Limestone – Barton Ash (Tumbled with sawn edge)

This grey limestone is gently undulated and has a tumbled surface with sawn edges for a wonderfully rustic, traditional look. This can be used for both indoor and outdoor projects



Paving / Tiles:

560 x random length x 22mm
(420, 560, 700, 840mm calibrated)

15.84m² coverage per pack

Single size 900 x 600 x 22mm
(Calibrated)

Swimming Pool Copings:

600 x 300 x 40mm
with full bullnose

Step Treads:

600 x 450 x 40mm
with full bullnose

Tumbled Setts:

200 x 100 x 40mm

200 x 50 x 40mm

Standard items:

90° Square & 6" Radius Corners

4ft & 5ft Roman Ends are made to order

Cut to size and bespoke profile available.

Bespoke:

Free-form shaped copings & bespoke stone work are made to measure in-house.

Site template service available.

Natural stone varies in both colour and texture. The appearance of the stone will change when wet, enhancing the natural tones within the stone.



Natural Stone

Limestone – Downton (Tumbled + Part Honed)

This olive/grey and buff tone stone is gently undulated and has been tumbled and part honed for a wonderfully understated and rustic traditional look. This can be used for both indoor and outdoor projects.



Paving / Tiles:

560 x random length x 22mm
(420, 560, 700 & 840mm calibrated)

15.84m² coverage per pack

Single size 900 x 600 x 22mm
(calibrated)

Swimming Pool Copings:

600 x 300 x 40mm

with full bullnose

Step Treads:

600 x 450 x 40mm

with full bullnose

Tumbled Setts:

200 x 100 x 40mm

200 x 50 x 40mm

Standard items:

90° Square & 6" Radius Corners

4ft & 5ft Roman Ends are made to order

Cut to size and bespoke profile available.

Bespoke:

Free-form shaped copings & bespoke stone work are made to measure in-house.

Site template service available.

Natural stone varies in both colour and texture. The appearance of the stone will change when wet, enhancing the natural tones within the stone.



Natural Stone
Limestone – Crema Europa (Sandblasted)

This dense creamy white limestone has a lightly sandblasted surface for slip resistance. Perfect for a luxury finish to any indoor pool project.



Tile:

- 900 x 600 x 20mm
- 600 x 600 x 20mm
- 600 x 400 x 20mm

Swimming Pool Copings:

- 600 x 300 x 40mm
with full bullnose edge

Step Treads:

- 600 x 450 x 40mm
with full bullnose edge

Standard items:

- 90° Square & 6" Radius Corners
- 4ft & 5ft Roman Ends are made to order
- Cut to size and bespoke profile available.

Bespoke:

- Free-form shaped copings & bespoke stone work are made to measure in-house.
- Site template service available.
- Natural stone varies in both colour and texture. Sandstone in particular will not be consistent in colour. The appearance of the stone will change when wet, enhancing the natural tones within the stone.

SLIP
3
DRY
C
WET
CE
APPROVED
FROST RESISTANT
BESPOKE PIECES



Natural Stone
Travertine – (Tumbled + Unfilled)

Our light cream/honey-toned Tumbled & Unfilled Travertine is full of natural character and texture, creating a wonderful rustic look to any indoor or outdoor project.



Tiles:
 610 x 406 x 12mm

Paving:
 610 x 406 x 30mm

Swimming Pool Copings:
 610 x 305 x 30mm
 with full bullnose
 610 x 305 x 30/50mm
 with full bullnosed over-lip

Step Treads:
 610 x 406 x 30mm
 with full bullnose

Tumbled Setts:
 200 x 100 x 30mm

Standard items:
 90° Square & 6" Radius Corners
 4ft & 5ft Roman Ends are made to order
 Cut to size and bespoke profile available.

Bespoke:
 Free-form shaped copings & bespoke stone work are made to measure in-house.
 Site template service available.
 Natural stone varies in both colour and texture.
 The appearance of the stone will change when wet, enhancing the natural tones within the stone.



Natural Stone
Sandstone – Cotswold Mint (Riven)

Our Cotswold Mint Riven Sandstone has been hand selected and calibrated to ensure only the best quality mint and light buff tones are chosen to create a wonderfully rustic and yet uplifting landscape.



Paving:

600 Series Mixed Patio Pack.
 16.74m² coverage per pack.
 22mm thick – calibrated
 (See page 109 for laying pattern)
 Single size 900 x 600 x 22mm (calibrated)

Swimming Pool Copings:

600 x 225 x 40mm
 600 x 300 x 40mm
 with full bullnose

Step Treads:

600 x 450 x 40mm
 with full bullnose

Tumbled Setts:

200 x 100 x 40mm
 200 x 50 x 40mm

Standard items:

90° Square & 6" Radius Corners
 4ft & 5ft Roman Ends are made to order
 Cut to size and bespoke profile available.

Bespoke:

Free-form shaped copings & bespoke stone work are made to measure in-house.

Site template service available.

Natural stone varies in both colour and texture. Sandstone in particular will not be consistent in colour. The appearance of the stone will change when wet, enhancing the natural tones within the stone.



Natural Stone
Sandstone – Raj (Riven)

This very popular riven sandstone contains subtle olive tones enhanced with a blend of warm browns and greys. It is the perfect, more affordable alternative to English York Stone. Ideal for any outdoor landscaping or swimming pool project.



Paving:

600 Series Mixed Patio Pack.
 20.25m² coverage per pack.
 22mm thick – calibrated
 (See page 109 for laying pattern)
 Single size 900 x 600 x 22mm (calibrated)

Swimming Pool Copings:

600 x 300 x 40mm
 with full bullnose

Step Treads:

600 x 450 x 40mm
 with full bullnose

Tumbled Setts:

200 x 100 x 40mm
 200 x 50 x 40mm

Standard items:

90° Square & 6" Radius Corners
 4ft & 5ft Roman Ends are made to order
 Cut to size and bespoke profile available.

Bespoke:

Free-form shaped copings & bespoke stone work are made to measure in-house.
 Site template service available.
 Natural stone varies in both colour and texture.
 Sandstone in particular will not be consistent in colour.
 The appearance of the stone will change when wet,
 enhancing the natural tones within the stone.



Natural Stone
Sandstone – Georgian Antique (Riven + Tumbled)

This natural riven grey sandstone has been tumbled to create an antique look, perfect for any pool surround and landscape project, with a traditional or vintage style.



Paving:

600 Series Mixed Patio Pack.
 16.74m² coverage per pack.
 22mm thick – calibrated
 (See page 109 for laying pattern)
 Single size 900 x 600 x 22mm (calibrated)

Swimming Pool Copings:

600 x 300 x 40mm
 with full bullnose

Step Treads:

600 x 450 x 40mm
 with full bullnose

Tumbled Setts:

200 x 100 x 40mm
 200 x 50 x 40mm

Standard items:

90° Square & 6" Radius Corners
 4ft & 5ft Roman Ends are made to order
 Cut to size and bespoke profile available.

Bespoke:

Free-form shaped copings & bespoke stone work are made to measure in-house.
 Site template service available.
 Natural stone varies in both colour and texture.
 Sandstone in particular will not be consistent in colour.
 The appearance of the stone will change when wet,
 enhancing the natural tones within the stone.



Natural Stone
Sandstone – Hawksworth (Riven + Tumbled)

This dark grey and golden riven sandstone, has been heavily tumbled to create a wonderfully authentic old English York look, for any external project.

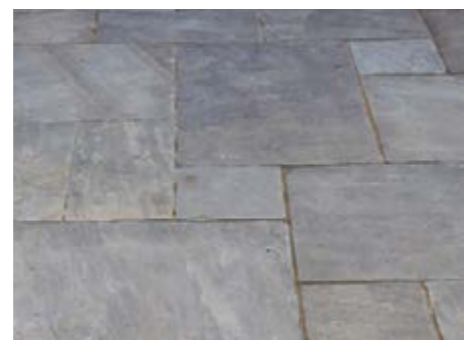

Paving:

600 Series Mixed Patio Pack.
 16.74m² coverage per pack.
 22mm thick – calibrated
 (See page 109 for laying pattern)
 900 x 600mm x 22mm (calibrated)

Swimming Pool Copings:

600 x 300 x 40mm
 with full bullnose

Step Treads:

600 x 450 x 40mm
 with full bullnose

Tumbled Setts:

200 x 100 x 40mm
 200 x 50 x 40mm

Standard items:

90° Square & 6" Radius Corners
 4ft & 5ft Roman Ends are made to order
 Cut to size and bespoke profile available.

Bespoke:

Free-form shaped copings & bespoke stone work are made to measure in-house.
 Site template service available.
 Natural stone varies in both colour and texture. Sandstone in particular will not be consistent in colour. The appearance of the stone will change when wet, enhancing the natural tones within the stone.



Natural Stone
Sandstone – Danebury (Honed)

This honed (smooth) sandstone with a combination of mint and buff tones and slip-resistance is ideal for any contemporary or traditional landscaping or swimming pool project.

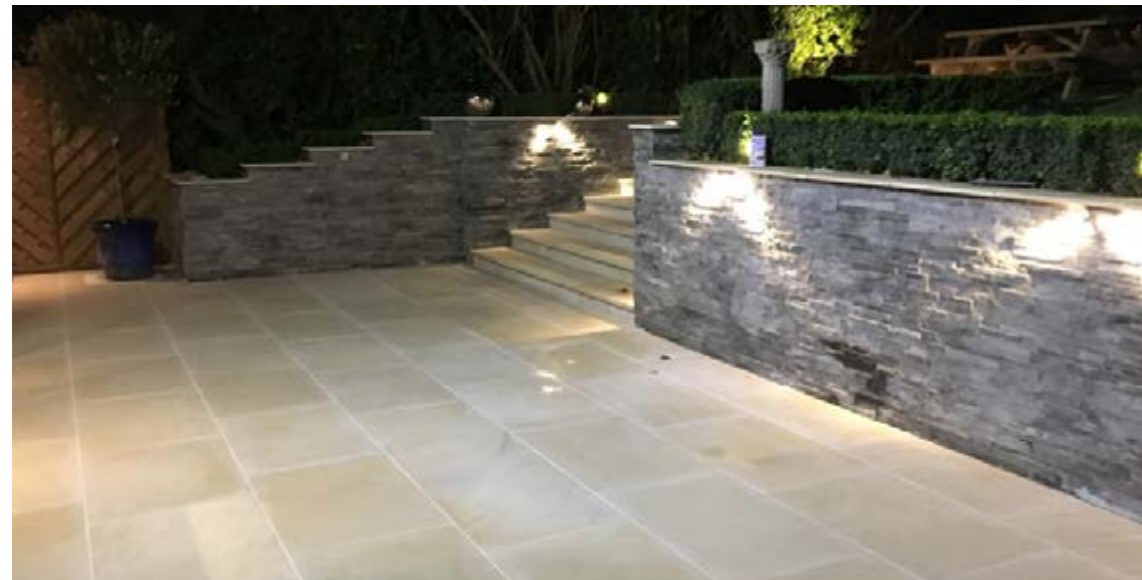

Paving:

Heritage Mixed Pack Paving.
 16.98m² coverage per pack.
 22mm thick – calibrated
 (See page 109 for laying pattern)
 Single size 900 x 600 x 22mm (calibrated)

Swimming Pool Copings:

600 x 300 x 40mm
 with full bullnose

Step Treads:

600 x 450 x 40mm
 with full bullnose

Tumbled Setts:

200 x 100 x 40mm
 200 x 50 x 40mm
 with tumbled edges

Standard items:

90° Square & 6" Radius Corners
 4ft & 5ft Roman Ends are made to order
 Cut to size and bespoke profile available.

Bespoke:

Free-form shaped copings & bespoke stone work are made to measure in-house.
 Site template service available.
 Natural stone varies in both colour and texture. Sandstone in particular will not be consistent in colour. The appearance of the stone will change when wet, enhancing the natural tones within the stone.



Natural Stone
Sandstone – Leckford (Sawn + Lightly Sandblasted)

A wonderfully elegant sandstone with buff to grey tones and lightly sandblasted textured surface for slip resistance. It has the charm of a traditional sawn English yorkstone. A stylish choice for any landscape or swimming pool project.



Paving:
 900 x 600 x 30mm

Swimming Pool Copings:
 600 x 300 x 40mm
 with full bullnose

Step Treads:
 600 x 450 x 40mm
 with full bullnose

Tumbled Setts:
 200 x 100 x 30mm
 200 x 50 x 40mm

Standard items:
 90° Square & 6" Radius Corners
 4ft & 5ft Roman Ends are made to order
 Cut to size and bespoke profile available.

Bespoke:
 Free-form shaped copings & bespoke stone work are made to measure in-house.
 Site template service available.
 Natural stone varies in both colour and texture.
 The appearance of the stone will change when wet, enhancing the natural tones within the stone.

SLIP
3
DRY
C
WET
CE
APPROVED
FROST RESISTANT
BESPOKE PIECES



Natural Stone
York Stone

Our York Stone direct from the Yorkshire quarries is of the highest quality. Available in both Sawn & Natural Riven finish, this is without doubt one of the most classic natural stones from the UK.



Paving:

Set Widths x Random Lengths x 38 – 63mm
(Set widths of 400, 500, 600mm)

Riven Finish

Set Width (600) x Random Length x 50mm
Sawn Finish

Swimming Pool Copings:

Sawn only

600 x 300 x 50mm
with full bullnose

Step Treads:

Sawn only

600 x 450 x 50mm
with full bullnose

Standard items:

90° Square & 6" Radius Corners

4ft & 5ft Roman Ends are made to order

Cut to size and bespoke profile available.

Bespoke:

Free-form shaped copings & bespoke stone work are made to measure in-house.

Site template service available.

Natural stone varies in both colour and texture. Sandstone in particular will not be consistent in colour. The appearance of the stone will change when wet, enhancing the natural tones within the stone.



Natural Stone
NEW Granite – Monxton Black (Flamed)

This stunning black granite with its gently flamed finish for slip resistance is the ideal stone for modern swimming pool surrounds and terraces.



Paving:
 600 x 600 x 20mm

Swimming Pool Copings:
 600 x 300 x 30mm
 with full bullnosed edge
 600 x 350 x 30/50mm
 with an over-lip (polished edge)

Steps:
 600 x 600 x 30mm
 with full bullnosed edge (honed)

Tumbled Setts:
 200 x 100 x 30mm
 200 x 50 x 30mm
 with tumbled edges

Standard items:
 90° Square & 6" Radius Corners
 4ft & 5ft Roman Ends are made to order
 Cut to size and bespoke profile available.

Bespoke:
 Free-form shaped copings & bespoke stone work are made to measure in-house.
 Site template service available.
 Natural stone varies in both colour and texture.
 The appearance of the stone will change when wet, enhancing the natural tones within the stone.



Natural Stone – Finishes.

Our natural stone range has been finely selected from countries world-wide and includes high quality Granite, Marble, Limestone, Travertine and Sandstone. All of which are available in various finishes and thicknesses:

Part of the beauty of natural stone is its tonal variation and organic properties. Being such a versatile material we are able to apply many finishes to the stone to create the following finishes:



- Honed**
A lightly polished surface using sand/water to remove any saw marks, resulting in a nice clean and smooth finish.
- Sandblasted**
A shot-blast media is fired at high pressure onto the stone resulting in a lightly textured surface with an increased slip resistance.
- Riven / Natural Cleft**
A natural undulated surface of layered stone (sandstone/slate) with natural variations.
- Tumbled**
Tumbled in machines filled with pebbles creating an appearance of a naturally time-aged worn surface.
- Antique**
Partly honed and then tumbled to create that aged look with a more muted finish.
- Satin**
Honed and then sandblasted for a greater slip resistant finish. An acid wash is then applied to enhance the colour of the stone.
- Flamed**
Using a mixture of heat and water, the stone is flamed to create a rugged textured surface, increasing slip resistance. Generally applied to Granite and Basalt.
- Sawn**
Straight cut edge tiles, with light sawn markings.
- Tumbled Grip**
Tumbled as above and then washed with acid to lightly etch the stone surface for a slip resistant finish.

Deck Level Grilles

A deck level pool / overflow pool is where the water's edge is the same level as the deck or patio and flows into a grate around the perimeter. A continuous gutter is fitted around the perimeter of the swimming pool, which acts as a skimmer, constantly flowing excess water into a balance tank and back through the circulation system. Cranbourne Stone have created a wide range of stylish and highly functional, removable Grille systems to sit on top of the gulley.

Deck Level Grilles

Stonetech Deck Level Grilles

We are delighted to become the UK's exclusive distributor for Stonetech Pools products. Stonetech have two factories in Greece. Using their fully automated technologically advanced machinery for cutting process of Natural Stone, the company achieves high production standards, satisfying even the most demanding needs.

The 3-piece module system is made to SPATA standards and with its sandblasted finish is suitable for both residential and commercial pool projects.

By stocking standard size grille systems in three materials in the UK, this will reduce the long lead times normally incurred in deck level grille orders.



Dished Grille with slots



2 x Linear Grille



Slotted Grille



STOCK PRODUCTS



FOSSIL PEARL



SILVER CLOUD



SILVER GREY



Deck Level Grilles
Stonetech 2x Slot Grille

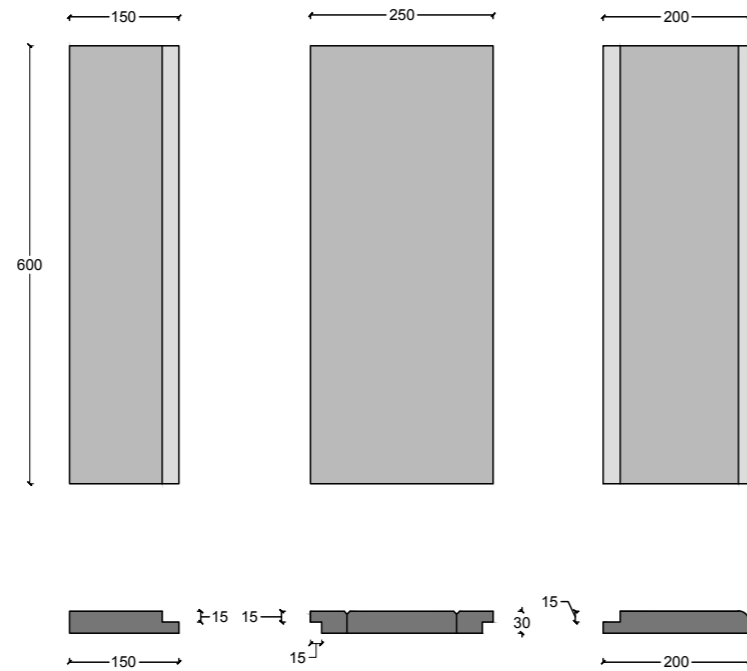
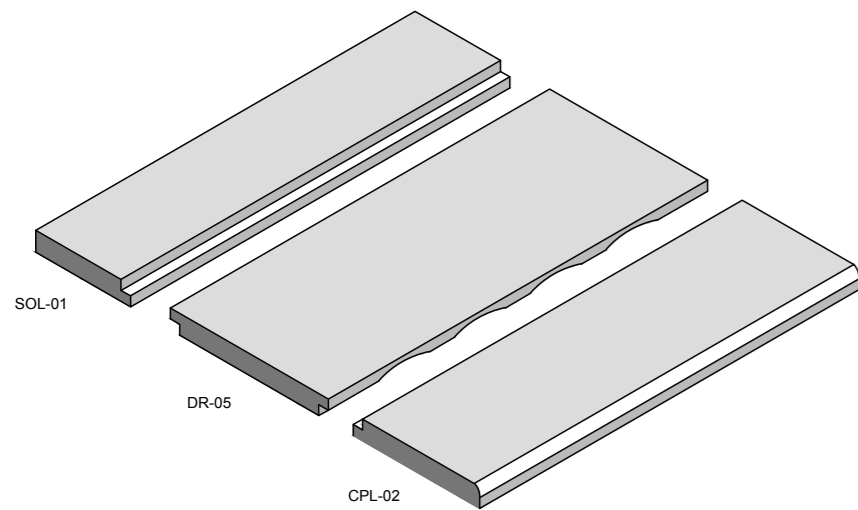

Deck Level Grilles
Stonetech Dished Grille

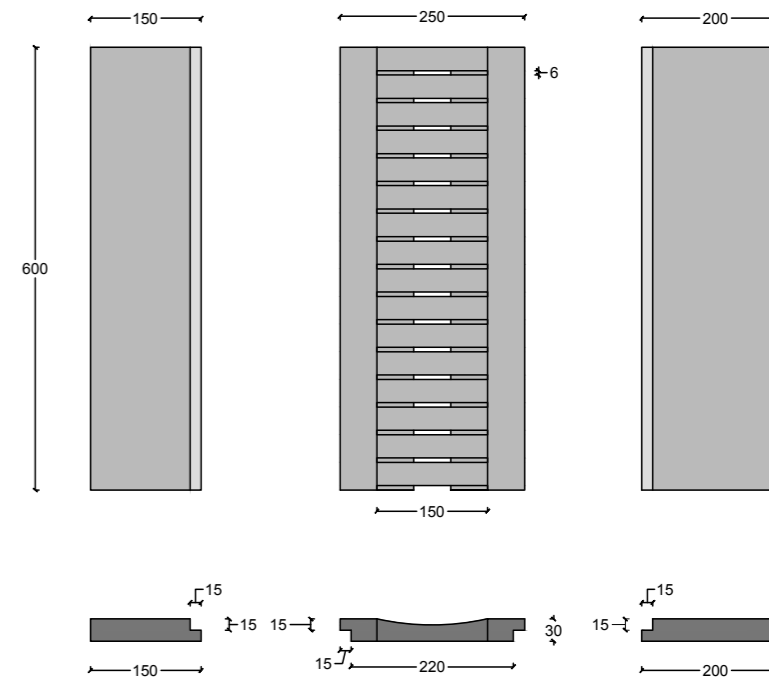
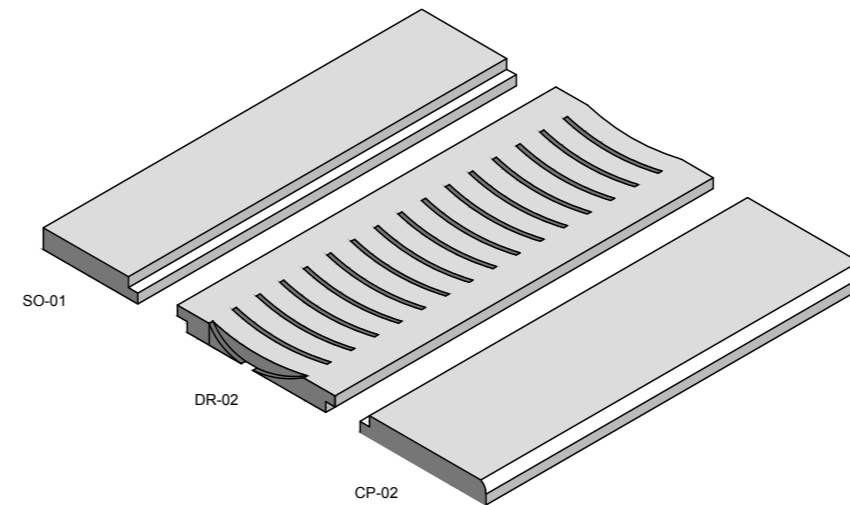

Deck Level Grilles
Stonetech Slotted Grille

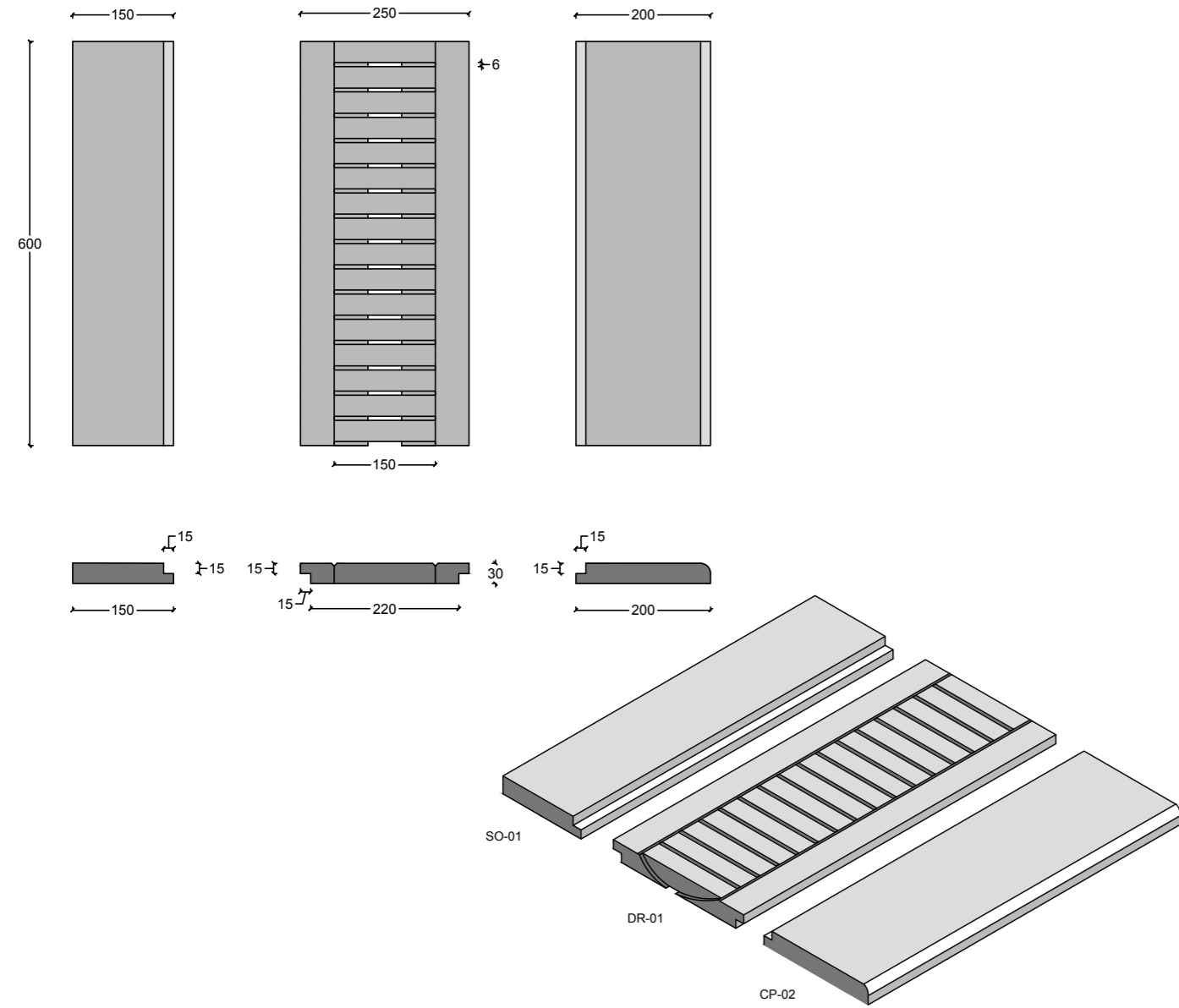

Deck Level Grilles
Stonetech Gallery



Porcelain Bespoke Deck Level Grilles
2x Slot Mono Grille – Porcelain

The 2x slot Mono Grille is a one-piece grille system with removable grille section, giving the look of a 3 piece module, but with the structural support of the under-frame and the unique anti-rocking grille piece, creating a stunning solution for both indoor and outdoor deck level pools.

These are made to order in-house, and are available in our full range of 20mm grip porcelain.

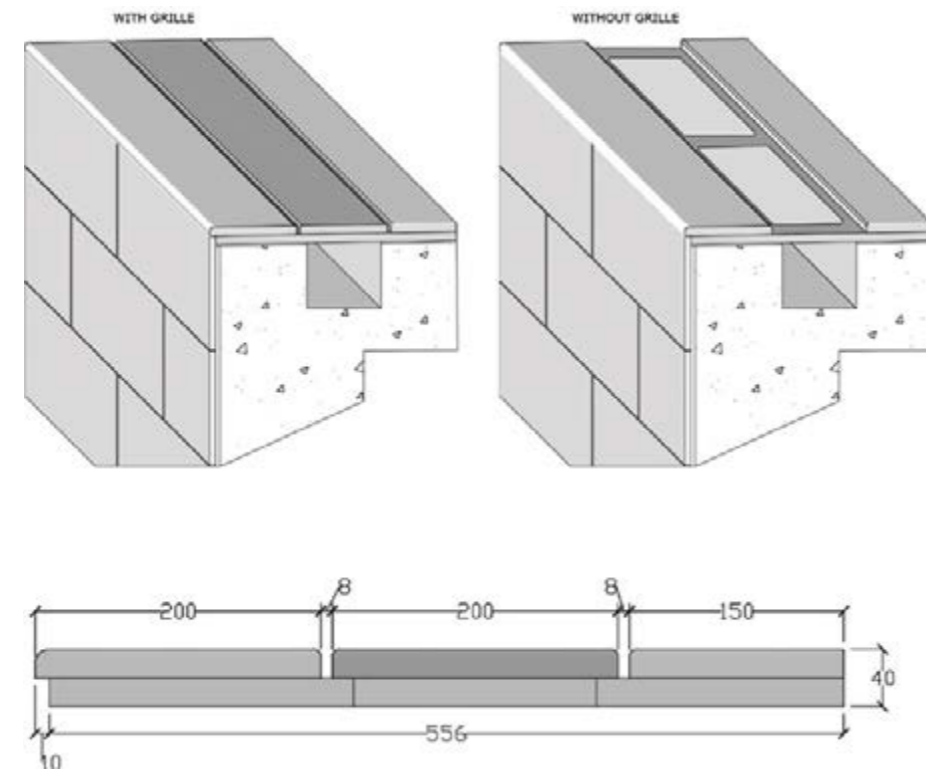

Porcelain Bespoke Deck Level Grilles
Linear Grid Grille – Porcelain

The Linear Grid Grille is the perfect modern replacement for old Astral / Certikin plastic grilles. This 20mm thick porcelain grille can be made from all of our 20mm grip porcelains and can match or compliment any porcelain surround. Made in-house in Stockbridge using our hi-tech waterjet machines for precision cutting, this can be backed with stainless steel for additional strength in higher traffic areas.



Oak Wood Porcelain 2x Slot Mono Grille

Natural Stone

Bespoke Deck Level Grilles

Cranbourne Stone's Bespoke Deck Level Grilles will add complete uniqueness, style and class to any individual pool.

Every set commissioned is made to the client's specification. Made in a variety of natural stone.

By using digital measuring equipment to take detailed measurements of any free-form / obscure shaped pool, Cranbourne are able to create precision CAD drawings and cutting schedules to create unique bespoke grille systems for any pool project.

Working to SPATA standards (Swimming Pool and Allied Trades Association), all bespoke deck level grilles made in-house using state of the art 5-axis CNC and waterjet machinery.

Our grilles are manufactured as a 'three-piece' module which includes the coping/beach as well as the bedding/backing stone. Each module has been designed so that the grille section can be removed, allowing easy access to the drainage channel below.

Linear Slot:

This grille has two linear slots running down the length. Our unique design allows water to flow away into a concealed drainage system. A very modern pool grille with a minimalistic look.

Contemporary:

The contemporary grille offers a stylish finish to the pool surround. Precision designed, it features a series of slots and flute grooves to minimise the wash of water onto the surrounding deck.

Dished:

With busy pools in mind, the gentle dish formed along the grille piece guides the water into the slots. A highly functional grille module that offers a luxurious solution with increased flow.

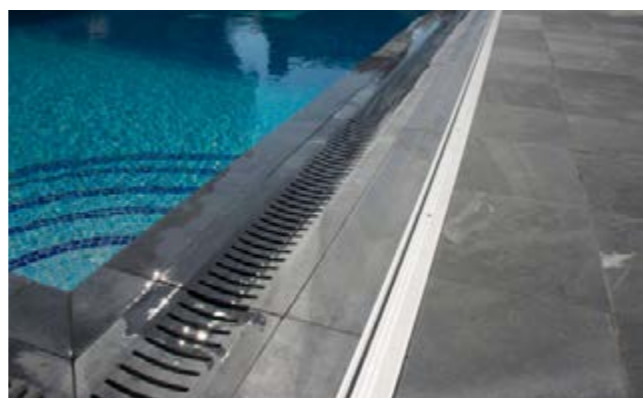

Crema Europa Limestone Linear Slot Grille

Deck Level Grilles
Gallery



Dished Grille



Dished Grille



Linear Slot Grille



2 x Slot Mono Grille

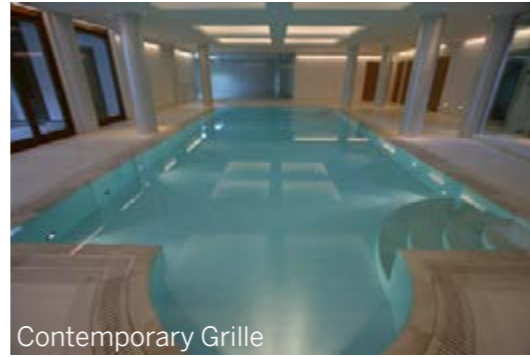

Contemporary Grille



Contemporary Grille

Porcelain

Porcelain tiles are made from a mix of natural clay and finely ground sand, which is then pressed and fired at a very high temperature. Each design is baked onto the body of the surface of the tile, to create natural looking tiles, which are durable, resistant to moss and mould, and easy to keep clean.

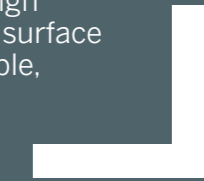

Porcelain Range

Our range includes 10 and 20mm thick tiles with a grip (slip-resistant finish) perfect for external projects, swimming pool surrounds and landscaping projects and 10mm complementing tiles with a smoother (honed) finish, perfect for internal floor/wall and pool tanks. Not only does the Porcelain create a perfectly contemporary finish to your project it is also highly durable, resistant to moss, mould and easy to keep clean. Utilising our waterjet and profiling machinery we are able to cut and shape porcelain effortlessly.

20mm Grip Range

This 20mm thick porcelain, with its R11 slip resistant finish and wide variety of natural stone looking prints is perfect for Swimming Pool Surrounds, outdoor terraces and bespoke landscaping projects.. With this range of Porcelain being stocked in our Hampshire factory, we are able to produce Pool Copings and bespoke pieces in-house with quick lead times to suit you.

Inside Out Range

Why not bring the inside out, with our range of 20mm and 10mm Porcelain tiles. With both R11 grip finishes in both thicknesses for external and indoor wet areas and a honed finish in 10mm for Pool tank lining for an alternative to mosaic tiles, or a stylish feature wall in the pool room, keeping the stylish Italian look whilst being safe at the same time.

Wood Porcelain Range

Wanting to create a contemporary, organic look without the hassle of high maintenance? Then look no further with our Wood Porcelain range ,with its R11 grip finish. These porcelain tiles has been inspired by natural wooden planks providing a fresh timber feel for your home.



20mm Grip Range – Porcelain

Available Sizes

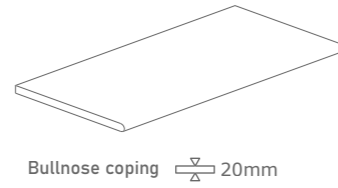

Bullnosed Copings

600 x 298 x 20mm
900 x 298 x 20mm
(Sirmione only)

Pencil Edge Step Treads

600 x 600 x 20mm
900 x 600 x 20mm
(Sirmione only)

Standard Items

90° square & 150mm radius corners
4ft & 5ft roman ends are made to order.
Cut to size and bespoke profiles also available

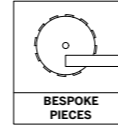
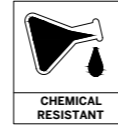

Sirmione



Lonato Grey



Lonato Grey Coping & Sirmione Paving

20mm Grip Range – Porcelain

Available Sizes

600 x 600



Ext R11 Grip

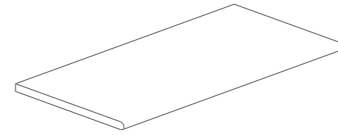

Bullnose coping 20mm

Bullnosed Copings

600 x 298 x 20mm

Pencil Edge Step Treads

600 x 600 x 20mm

Standard Items

90° square & 150mm radius corners

4ft & 5ft roman ends are made to order.

Cut to size and bespoke profiles also available

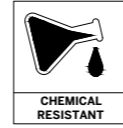

CHEMICAL RESISTANT



SLIP RESISTANT

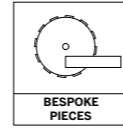

BESPOKE PIECES



FROST RESISTANT

Namur Light

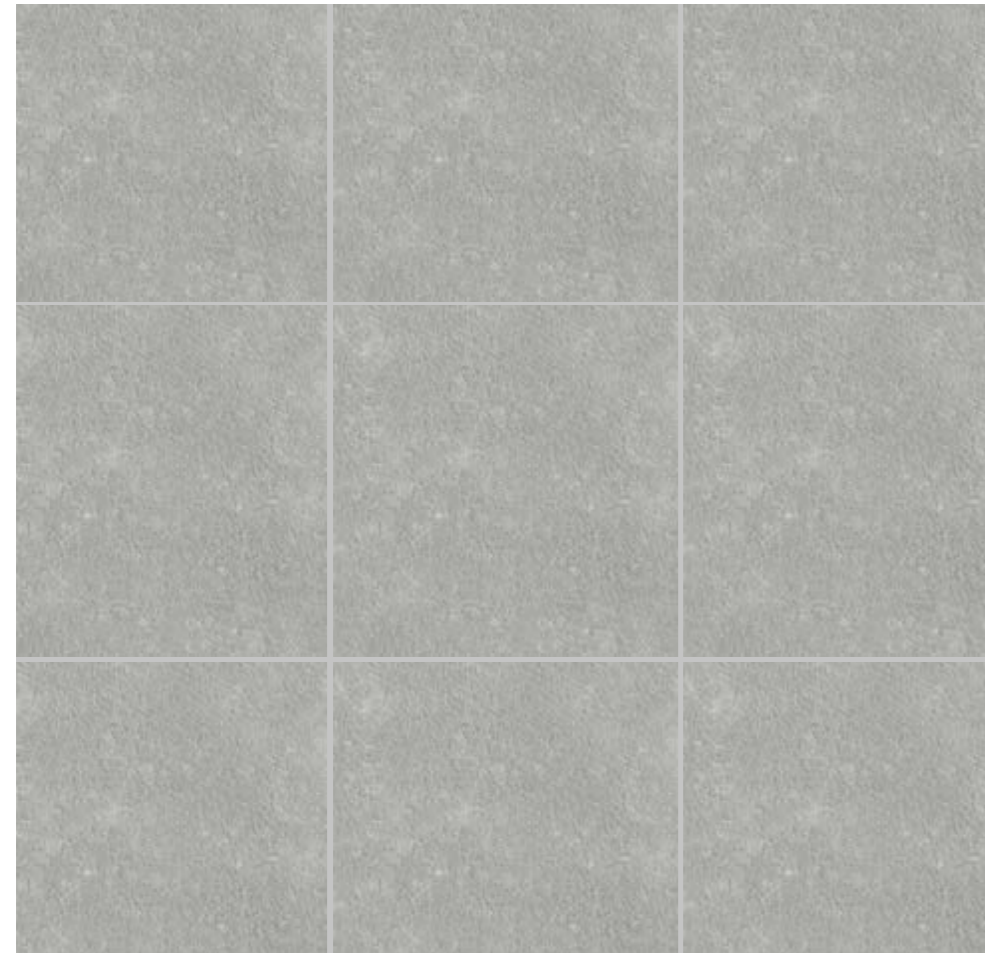

Namur Dark



Namur Dark Coping & Namur Light Paving

20mm Grip Range – Porcelain

Available Sizes

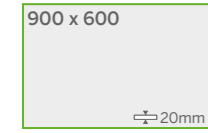

Ext R11 Grip

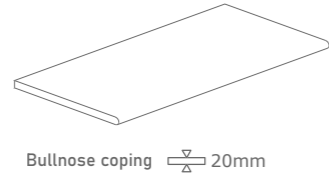

Bullnosed Copings

900 x 298 x 20mm

Pencil Edge Step Treads

900 x 600 x 20mm

Standard Items

90° square & 150mm radius corners

4ft & 5ft roman ends are made to order.

Cut to size and bespoke profiles also available

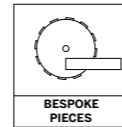
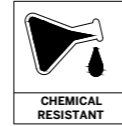

20mm Grip Range – Porcelain

Available Sizes



Ext R11 Grip

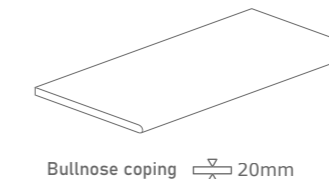

Bullnosed Copings

900 x 298 x 20mm

Pencil Edge Step Treads

900 x 600 x 20mm

Standard Items

90° square & 150mm radius corners

4ft & 5ft roman ends are made to order.

Cut to size and bespoke profiles also available

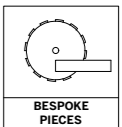

Carbis Sands



Burley Black



20mm Grip Range – Porcelain

Available Sizes



Ext R11 Grip

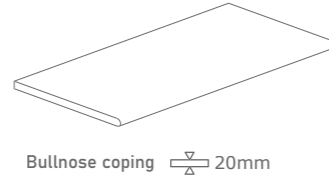

Bullnosed Copings

900 x 298 x 20mm

Pencil Edge Step Treads

900 x 600 x 20mm

Standard Items

90° square & 150mm radius corners

4ft & 5ft roman ends are made to order.

Cut to size and bespoke profiles also available

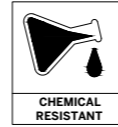

CHEMICAL RESISTANT



SLIP RESISTANT

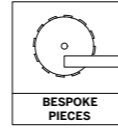

BESPOKE PIECES



FROST RESISTANT

Rockford Quartz



Bolzano



Bolzano Coping with Travertine Bianco Cross

20mm Grip Range – Porcelain

Available Sizes

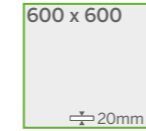

Ext R11 Grip

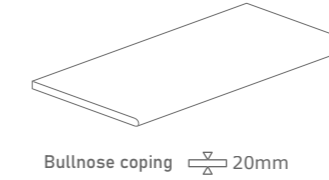

Bullnose coping 20mm

Bullnosed Copings

600 x 298 x 20mm

Bonded Over-lip Copings

600 x 298 x 20/50mm

Pencil Edge Step Treads

600 x 600 x 20mm

Standard Items

90° square & 150mm radius corners

4ft & 5ft roman ends are made to order.

Cut to size and bespoke profiles also available

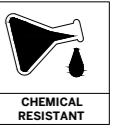

CHEMICAL RESISTANT



SLIP RESISTANT

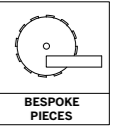

BESPOKE PIECES



FROST RESISTANT

Bruges Beige



Bruges Beige Porcelain

Ghent Grey



Ghent Grey Porcelain



20mm Grip Range – Porcelain

Available Sizes

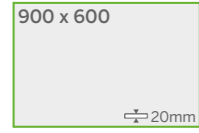

Ext R11 Grip

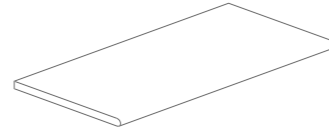

Bullnose coping 20mm

Bullnosed Copings

900 x 298 x 20mm

Pencil Edge Step Treads

900 x 600 x 20mm

Standard Items

90° square & 150mm radius corners

4ft & 5ft roman ends are made to order.

Cut to size and bespoke profiles also available

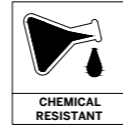

CHEMICAL RESISTANT



SLIP RESISTANT

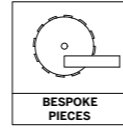

BESPOKE PIECES



FROST RESISTANT

Loretto Buff



Loretto Buff Coping & Sirmione Paving

Sorrento



Sorrento Porcelain



20mm Grip Range – Porcelain

Available Sizes



Ext R11 Grip

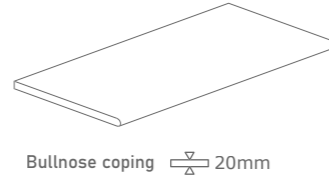

Bullnosed Copings

900 x 298 x 20mm

Pencil Edge Step Treads

900 x 600 x 20mm

Standard Items

90° square & 150mm radius corners

4ft & 5ft roman ends are made to order.

Cut to size and bespoke profiles also available

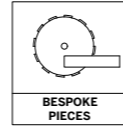
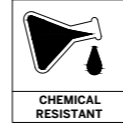

Rialto Crema



Rialto Grigio



Rialto Grigio Porcelain

Inside Out Range – Porcelain

Available Sizes

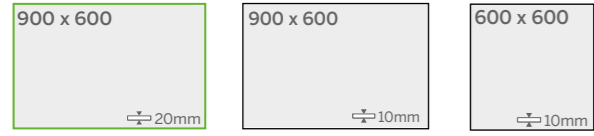

900 x 600 Ext R11 Grip
 900 x 600 Grip & Honed
 600 x 600 Honed Only

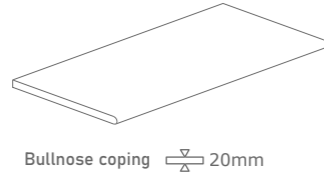

Bullnose coping 20mm

Bullnosed Copings

900 x 298 x 20mm

Pencil Edge Step Treads

900 x 600 x 20mm

Standard Items

90° square & 150mm radius corners

4ft & 5ft roman ends are made to order.

Cut to size and bespoke profiles also available

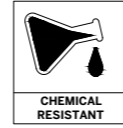

CHEMICAL RESISTANT



SLIP RESISTANT

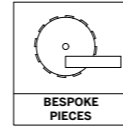

BESPOKE PIECES



FROST RESISTANT

Cadiz Beige



Cadiz Beige Porcelain

Inside Out Range – Porcelain

Available Sizes

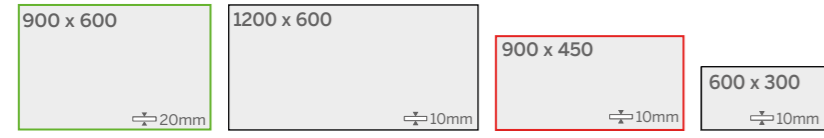

900 x 600 Ext R11 Grip
 1200 x 600 Grip & Honed
 900 x 450 Honed Only
 600 x 300

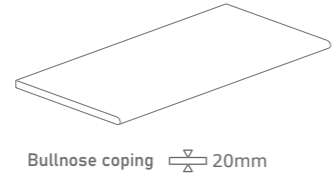

Bullnose coping 20mm

Bullnosed Copings

900 x 298 x 20mm

Pencil Edge Step Treads

900 x 600 x 20mm

Standard Items

90° square & 150mm radius corners

4ft & 5ft roman ends are made to order.

Cut to size and bespoke profiles also available

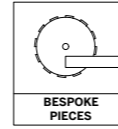
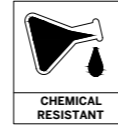

Caulfield Green



Waterford Cream



Waterford Porcelain with Leckford Sandstone Coping

Inside Out Range – Porcelain

Available Sizes

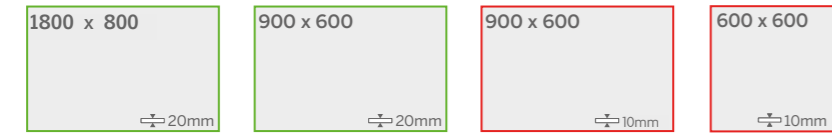

1800 x 800 Ext R11 Grip
 900 x 600 Grip & Honed
 900 x 600 Honed Only
 600 x 600 Honed Only
 600 x 300 Honed Only

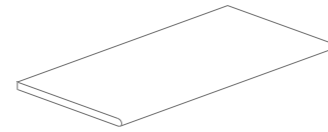

Bullnose coping 20mm



600 x 300 10mm

Bullnosed Copings

900 x 298 x 20mm

Bonded Over-lip Coping

900 x 298 x 20/50mm

Pencil Edge Step Treads

900 x 600 x 20mm

Standard Items

90° square & 150mm radius corners

4ft & 5ft roman ends are made to order.

Cut to size and bespoke profiles also available

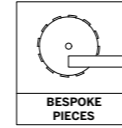

Portland Cream



Inside Out Range – Porcelain

Available Sizes

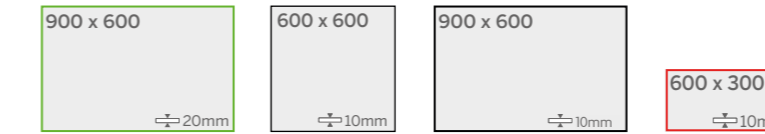

900 x 600 Ext R11 Grip
 600 x 600 Grip & Honed
 900 x 600 Grip & Honed
 600 x 300 Honed Only

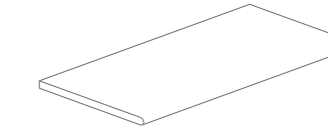

Bullnose coping 20mm

Bullnosed Copings

900 x 298 x 20mm

Pencil Edge Step Treads

900 x 600 x 20mm

Standard Items

90° square & 150mm radius corners

4ft & 5ft roman ends are made to order.

Cut to size and bespoke profiles also available

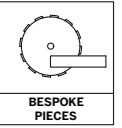

Studland Beige



Inside Out Range – Porcelain

Available Sizes

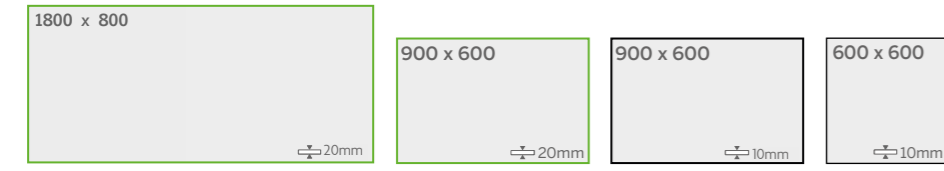

 Ext R11 Grip
 Grip & Honed
 Honed Only

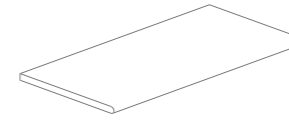

Bullnose coping 20mm



600 x 300 10mm

Bullnosed Copings

900 x 298 x 20mm

Bonded Overlip Copings

900 x 298 x 20/50mm

600 x 600 x 20/50mm

Pencil Edge Step Treads

900 x 600 x 20mm

Standard Items

90° square & 150mm radius corners

4ft & 5ft roman ends are made to order.

Cut to size and bespoke profiles also available

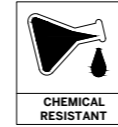

CHEMICAL RESISTANT



SLIP RESISTANT R11

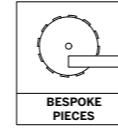

BESPOKE PIECES



FROST RESISTANT

Bridport Grey



Bridport Grey Paving with Namur Dark Porcelain Strip

Inside Out Range – Porcelain

Available Sizes

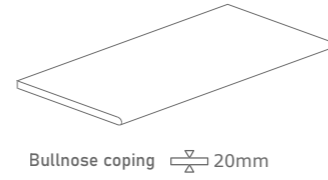
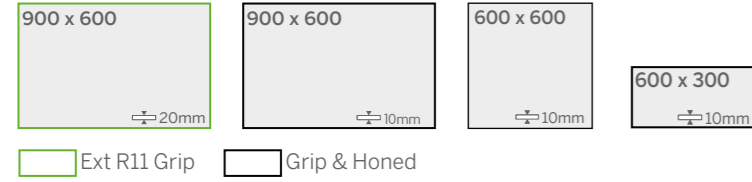

Bullnosed Copings
900 x 298 x 20mm

Pencil Edge Step Treads
900 x 600 x 20mm

Standard Items
90° square & 150mm radius corners
4ft & 5ft roman ends are made to order.
Cut to size and bespoke profiles also available

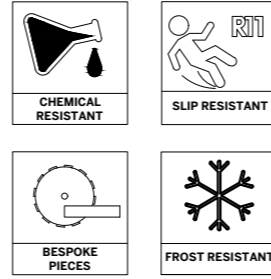

Buscot Pearl



Buscot Ash



Buscot Crema

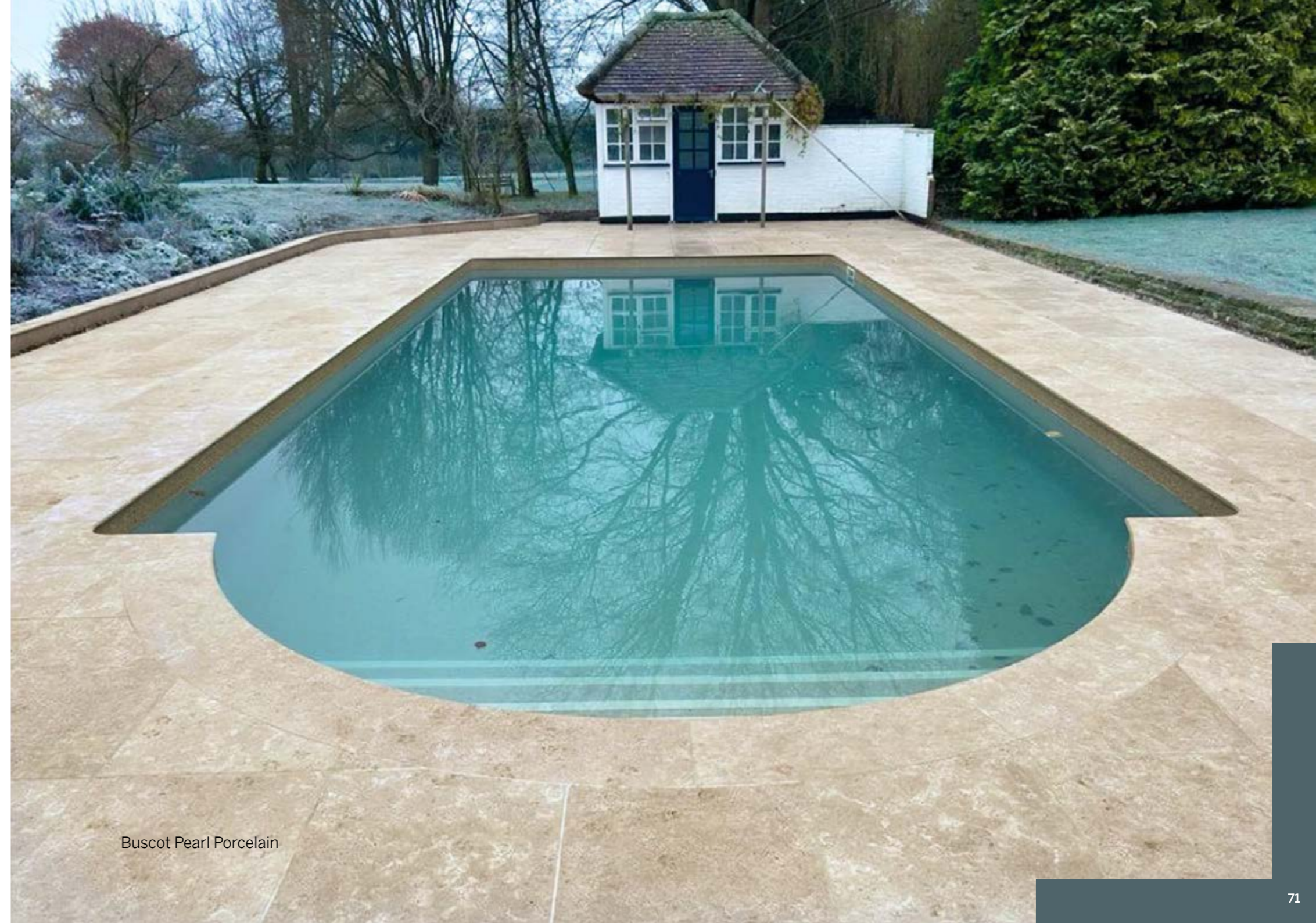

Buscot Pearl Porcelain

Inside Out Range – Porcelain

Available Sizes

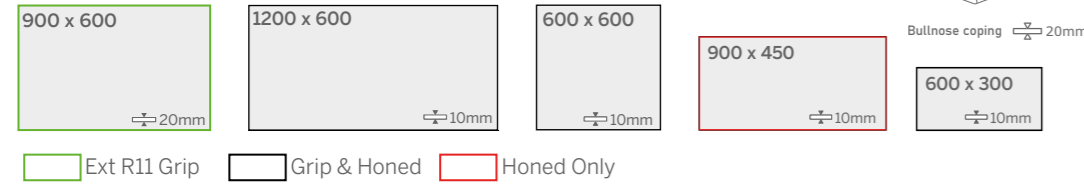

Bullnosed Copings

900 x 298 x 20mm

Pencil Edge Step Treads

900 x 600 x 20mm

Standard Items

90° square & 150mm radius corners

4ft & 5ft roman ends are made to order.

Cut to size and bespoke profiles also available

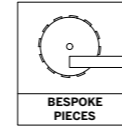
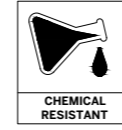

Meon Quartz



Meon Quartz Porcelain

Inside Out Range – Porcelain

Available Sizes



 Ext R11 Grip
 Grip & Honed
 Honed Only

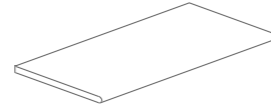

Bullnose coping 20mm

Bullnosed Copings

900 x 298 x 20mm

Pencil Edge Step Treads

900 x 600 x 20mm

Standard Items

90° square & 150mm radius corners

4ft & 5ft roman ends are made to order.

Cut to size and bespoke profiles also available

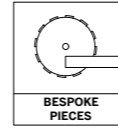
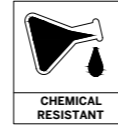

Houghton Grey



Houghton Grey Porcelain

Inside Out Range – Porcelain

Available Sizes

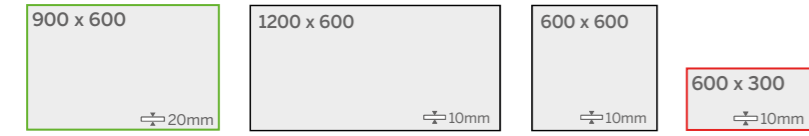

900 x 600 Ext R11 Grip
 1200 x 600 Grip & Honed
 600 x 300 Honed Only

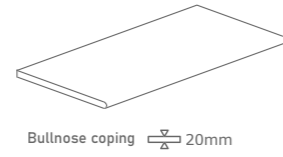

Bullnose coping 20mm

Bullnosed Copings

900 x 298 x 20mm

Pencil Edge Step Treads

900 x 600 x 20mm

Standard Items

90° square & 150mm radius corners

4ft & 5ft roman ends are made to order.

Cut to size and bespoke profiles also available

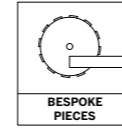
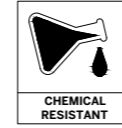

Awbridge Cream



Awbridge Cream Tiles with Mottisfont Grey Porcelain Coping and feature wall

Inside Out Range – Porcelain

Available Sizes

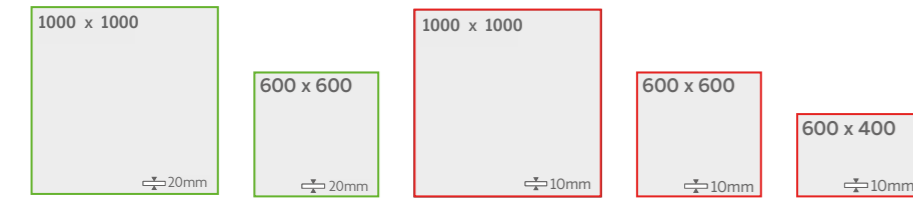

Ext R11 Grip Grip & Honed Honed Only

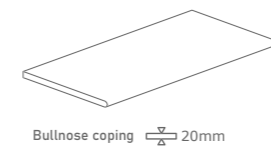

Bullnosed Copings

1000 x 498 x 20mm

Pencil Edge Step Treads

1000 x 1000 x 20mm

Standard Items

90° square & 150mm radius corners

4ft & 5ft roman ends are made to order.

Cut to size and bespoke profiles also available

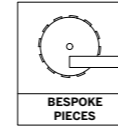
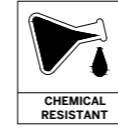

Sarum Grey



Sarum Grey Porcelain

Inside Out Range – Porcelain

Available Sizes

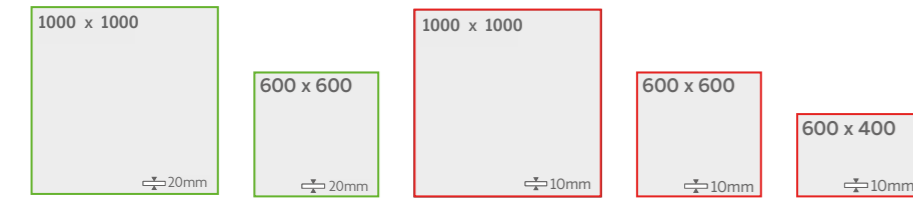

Ext R11 Grip Grip & Honed Honed Only

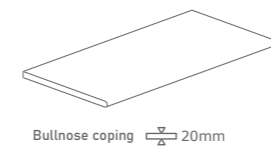

Bullnosed Copings

1000 x 498 x 20mm

Pencil Edge Step Treads

1000 x 1000 x 20mm

Standard Items

90° square & 150mm radius corners

4ft & 5ft roman ends are made to order.

Cut to size and bespoke profiles also available

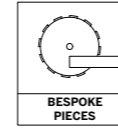
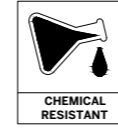

Wilton Beige



Wilton Beige Porcelain

Inside Out Range – Porcelain

Available Sizes

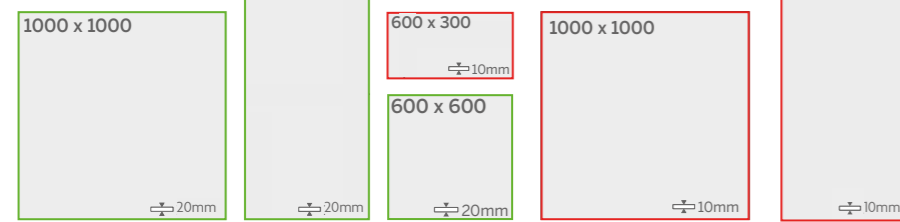

 Ext R11 Grip
 Grip & Honed
 Honed Only

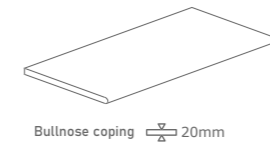

Bullnosed Copings

600 x 298 x 20mm

Pencil Edge Step Treads

600 x 600 x 20mm

Standard Items

90° square & 150mm radius corners

4ft & 5ft roman ends are made to order.

Cut to size and bespoke profiles also available

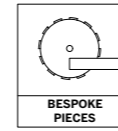
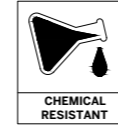

Concrete Grey



Concrete Beige



Concrete White



Concrete White Porcelain

Inside Out Range – Porcelain

Available Sizes

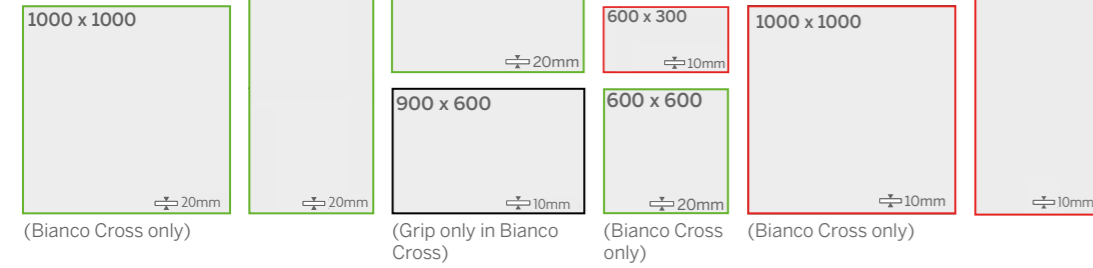

Ext R11 Grip Grip & Honed Honed Only

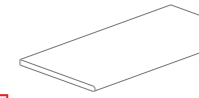

Bullnose coping 20mm

Bullnosed Copings

1200 x 298 x 20mm

Pencil Edge Step Treads

1200 x 600 x 20mm

Standard Items

90° square & 150mm radius corners
4ft & 5ft roman ends are made to order.

Cut to size and bespoke profiles also available

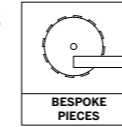
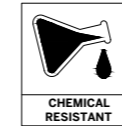

Travertine Bianco Cross



Travertine Vein White



Travertine Bianco Cross Porcelain

Inside Out Range – Porcelain

Available Sizes

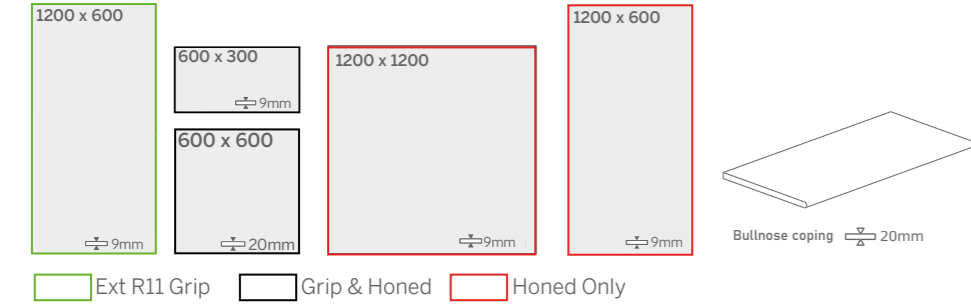

Bullnosed Copings
1200 x 298 x 20mm
Pencil Edge Step Treads
1200 x 600 x 20mm

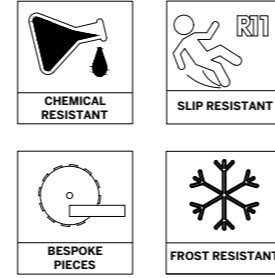

Roach Pearl



Roach Pearl Porcelain

Roach Grey



Roach Grey Porcelain



Wood – Porcelain

Available Sizes

1200 x 300
± 20mm

Ext R11 Grip

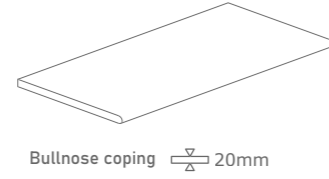

Bullnosed Copings
1200 x 300 x 20mm
Pencil Edge Step Treads
1200 x 300 x 20mm
Cut to size and bespoke profiles also available

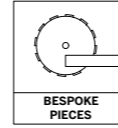
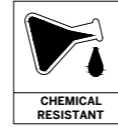

Ash



Oak



Ash Wood Porcelain

Exagres Extruded Porcelain

Available Sizes

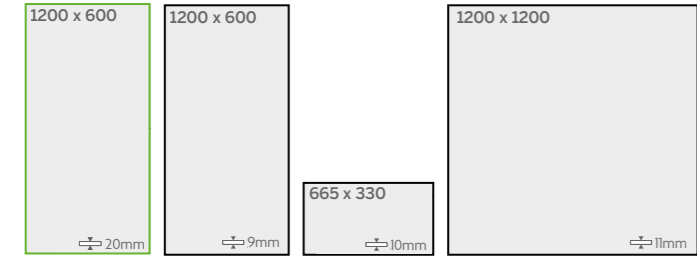

Ext R11 Grip Grip & Honed

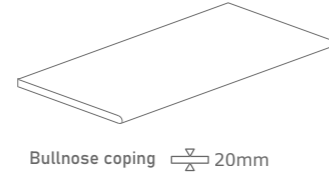

Bullnosed Copings
750 x 450 x 30mm
Over-lip Coping
1200 x 330 x 11/30mm

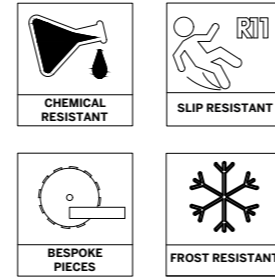

Exagres Extruded Porcelain

Available Sizes

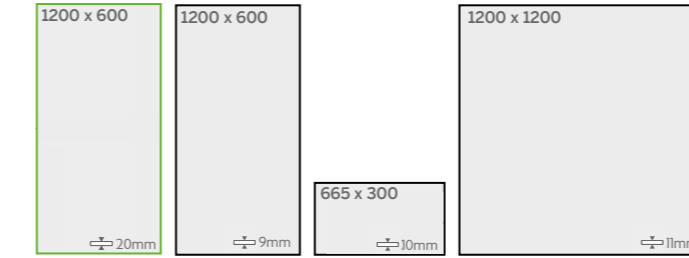

Ext R11 Grip Grip & Honed

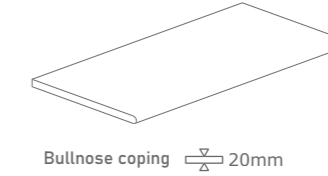

Bullnosed Copings
750 x 450 x 30mm
Over-lip Coping
1200 x 330 x 12/30mm

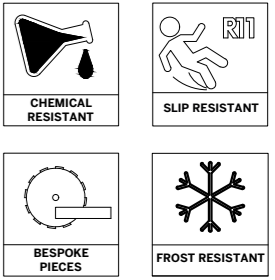

Marfil



Cromo



Exagres Extruded Porcelain

Available Sizes



Ext R11 Grip Grip & Honed

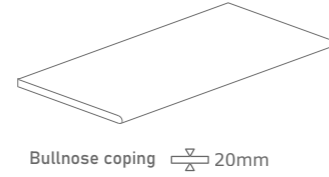

Bullnosed Copings
750 x 450 x 30mm
Over-lip Coping
1200 x 330 x 11/30mm

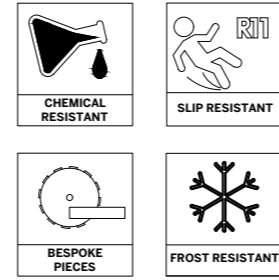

Exagres Extruded Porcelain

Available Sizes

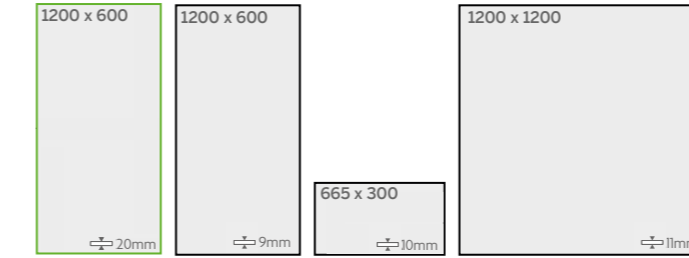

Ext R11 Grip Grip & Honed

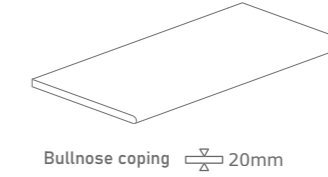

Bullnosed Copings
750 x 450 x 30mm
Over-lip Coping
1200 x 330 x 11/30mm

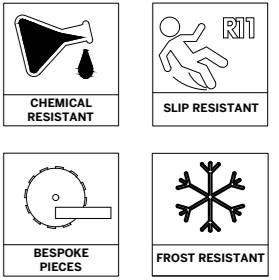

Gris



Anthracite



Roman End Bays and Corners

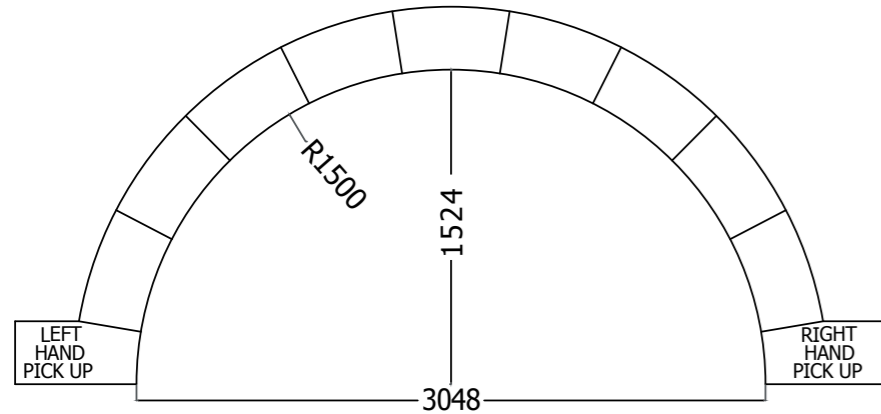

5FT ROMAN END BAY
(finished wall to wall measurements)

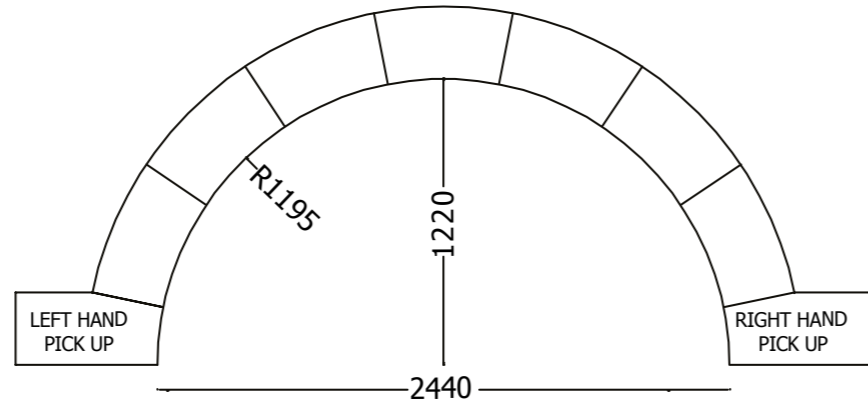

4FT ROMAN END BAY
(Country leisure 10ft roman end bay)
(finished wall to wall measurements)

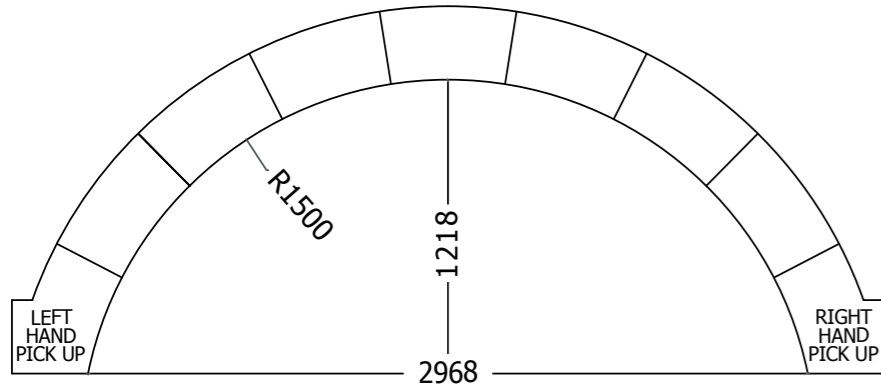

5FT LOW PROFILE ROMAN END BAY
(Country leisure 12ft roman end bay)
(finished wall to wall measurements)

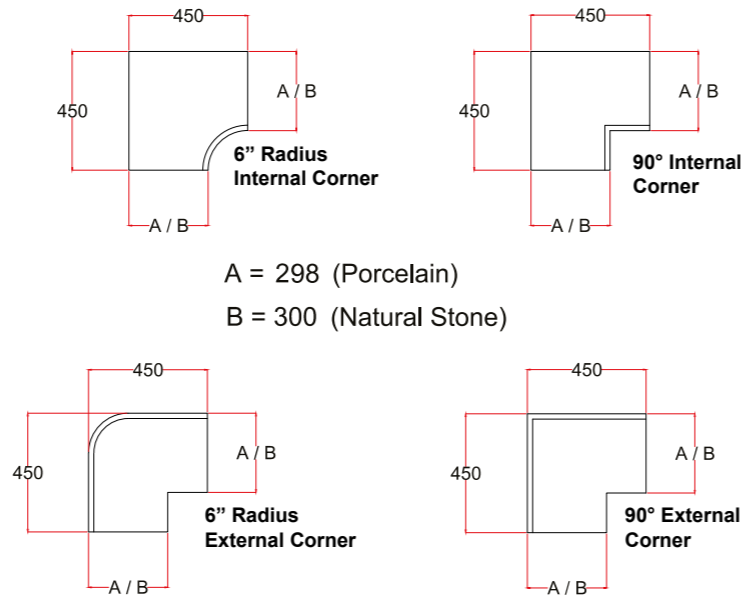

Porcelain Bespoke Pieces

Porcelain tiles are made from a mix of natural clay and finely ground sand, which is then pressed and fired at a very high temperature. Each design is baked onto the body of the surface of the tile, to create natural looking tiles.

When sourcing our porcelain for fabrication of pool copings, we endeavour to choose the best quality material.

We have always chosen material where the body of the tile is a similar tone to the top of the tile, making it as aesthetically pleasing as possible when profiled.

Over the last 18 months, due to the Ukraine War & price increases in energy supplies, the factories producing the material have had to change some of their raw materials & production methods.

Unfortunately, we have now found that most of the porcelain coming in has a visible line going through the centre of the body of the tile.

This does not show on standard porcelain pool copings, but when cutting the Corners, Roman Ends & Free-Form pieces the line can be visible.

If the visible line causes a concern, we would recommend selecting the square mitred corners or 6 inch Radius 50P corners, where the factory edge of the tile is profiled. If the pool has a Roman End, we would suggest showing the line on all of the copings, so the line is consistent and does not look out of place.

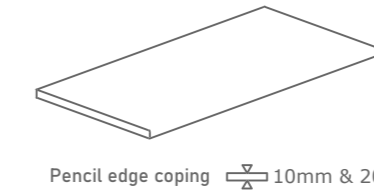

Pencil edge coping 10mm & 20mm

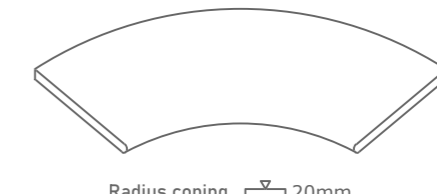

Radius coping 20mm

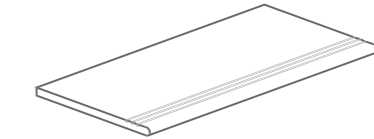

Bullnose gradino coping 20mm



Internal radius corner 20mm

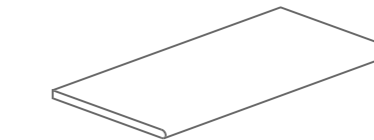

Bullnose coping 20mm

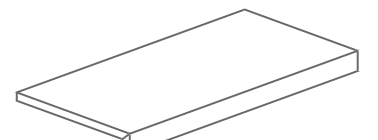

Drop edge coping 20mm

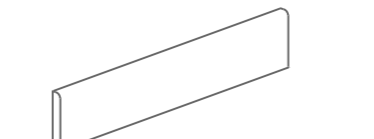

Skirting tile 10mm & 20mm

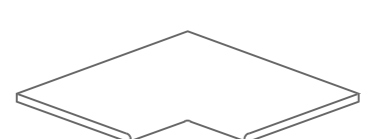

Internal corner 20mm

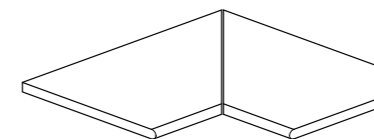

Internal corner mitred 20mm

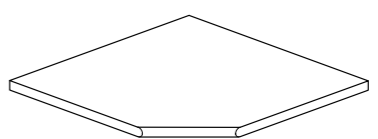

Internal corner 6 inch radius 50P 20mm

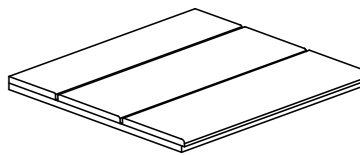
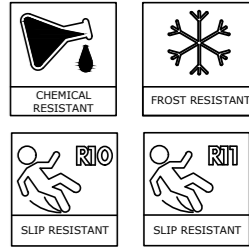

2x slot mono grille 40mm

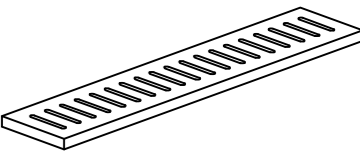

Drainage gully 20mm

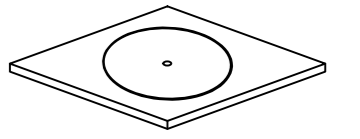

Inspection covers 20mm

Swimming Pool Coping Options

Here are a selection of images to show the different coping styles.



Freeform bullnosed



Square Edge with pencil edge top & bottom



Porcelain Over-lip coping with automatic poolcover system



Full Bullnose with Automatic Cover channel



Full Bullnose with liner Lock

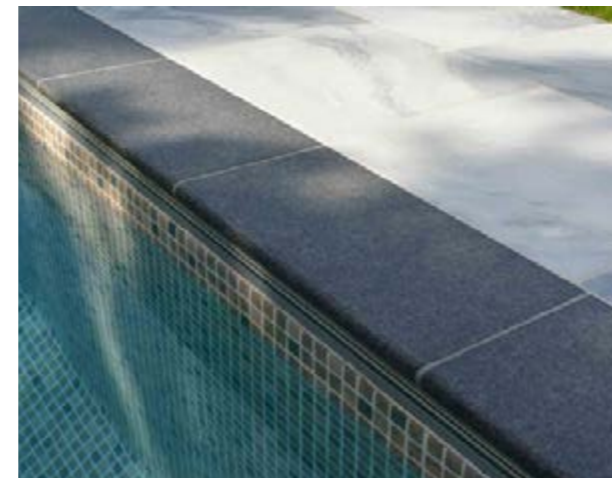

Bullnosed Coping in contrasting colour to define the edge

Edge Profiles & Swimming Pool Copings

Using our extensive experience and knowledge in swimming pool installation, we have supplied swimming pool copings and surrounds nationwide for 20 years.

Working with architects, designers and pool installers over this time has allowed us to utilise our vast knowledge to enable our customers to bring their complex projects through to fruition, therefore broadening our prodigious portfolio. Our range of pool surrounds is ever expanding and our materials are selected specifically for this purpose. We have standard stock size pool copings, corners and Roman end kits, in both natural stone and porcelain. Our bespoke service is available for more complex projects. Please see below details of the standard components:-

Please note that some porcelain has a line in the base of the tile which shows on the profiled edge on roman ends and radius corners. Please ask for details on this before selecting your porcelain.

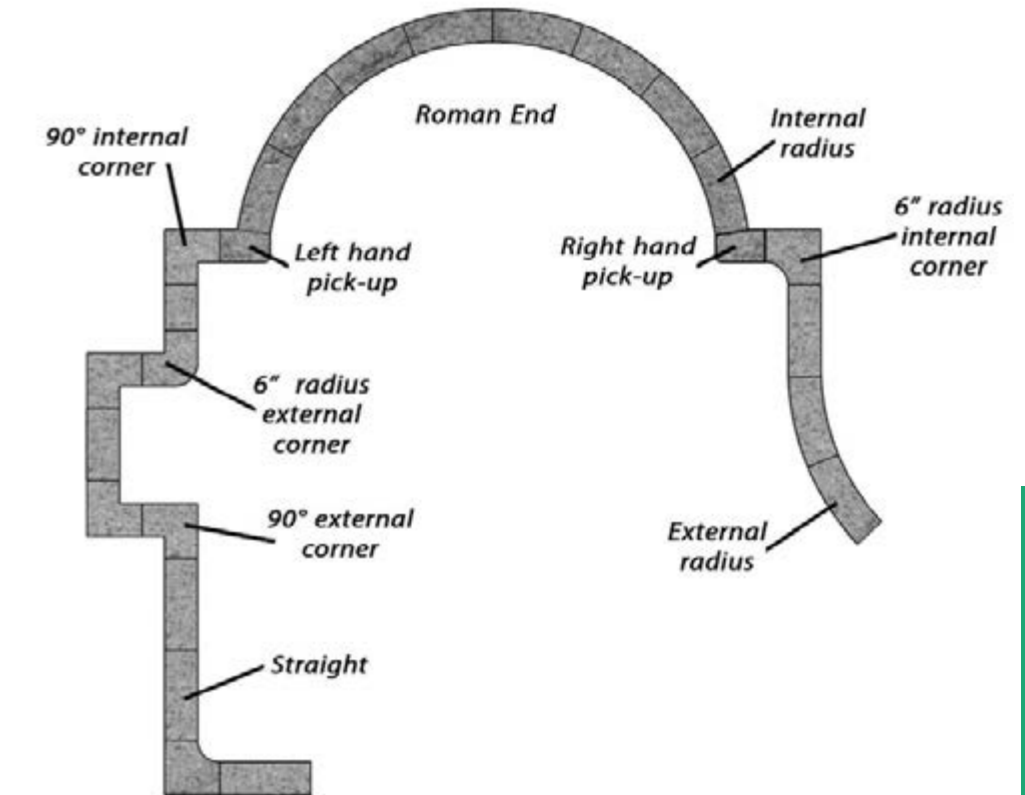
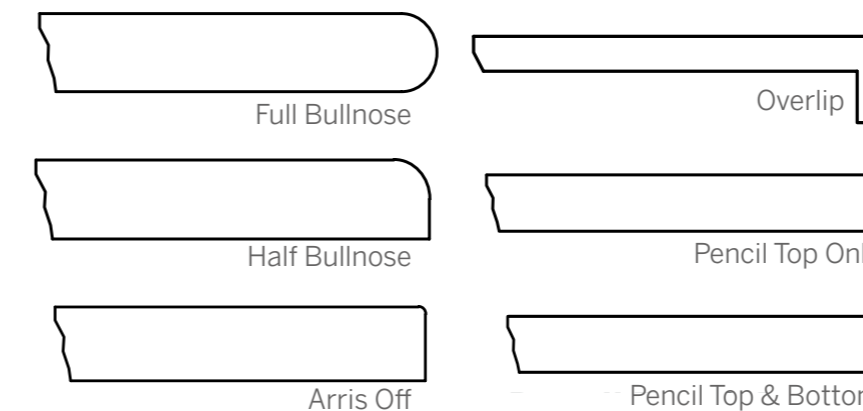

New Glass Mosaics

Teaming up with Togama, we are now able to supply a wide range of beautiful Glass Mosaics to complement our existing well established Pool Copings and Surrounds.



Check out our fabulous new brochure your key to unlocking a world of stunning mosaic pools.

[View on our website](#)

Pool Tank Mosaics

Pool Tank – Large Format Tiles

As an alternative to traditional Swimming Pool Mosaics, our range of large format 10mm tiles are an excellent way of creating a sleek and modern look of the internal finish to any Swimming Pool.

The colour of the water is created by the choice of tile used. Obviously setting, lighting and weather play a part in how the pool water looks, however as a general rule of thumb, please follow our handy guide below.



For a bright blue/turquoise Mediterranean colour, we would recommend a white, cream or sandy coloured tile.



AWBRIDGE CREAM*

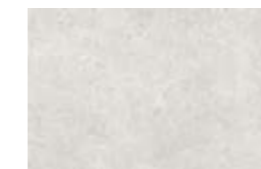

PORTLAND CREAM*

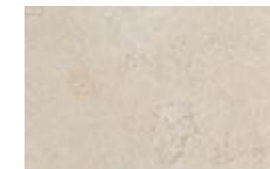

CADIZ BEIGE*



WEXFORD SANDS*



For a mid-blue colour, we would recommend a light grey / pale blue coloured tile.



HOUGHTON GREY*



MEON QUARTZ*



SARUM GREY



BRIDPORT GREY*



For a dark blue pond like colour, we recommend a dark blue, dark green or black coloured tile.



CAULFIELD GREEN*

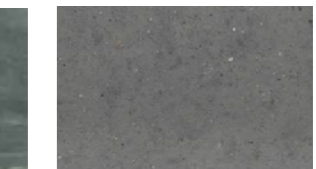

WINTERBOURNE GREY*

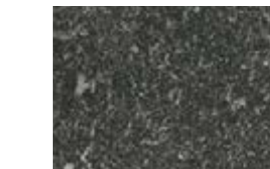

EXAGRES ANTHRACITE



SATIN BLACK

Site Template / Survey

Taking the responsibility away from the builder by sending our surveyor to site with our digital templating device, takes a huge weight from busy shoulders.

By using our laser to digitally measure any freeform/obscure shaped pool/landscape area, we can create a CAD drawing and cutting schedule, which can be loaded straight into the machinery in our yard, ready to start precision cutting.

Benefiting from our CNC waterjet, 5 axis saw and profiling machinery we are able to produce bespoke work easily, efficiently and speedily.

Give us a call to discuss your next project. We have the materials, technology and experience to make your designs achievable!

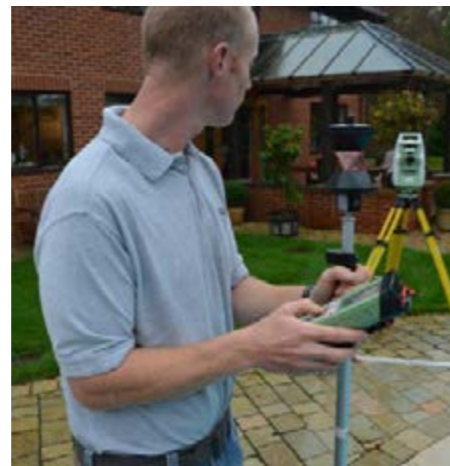
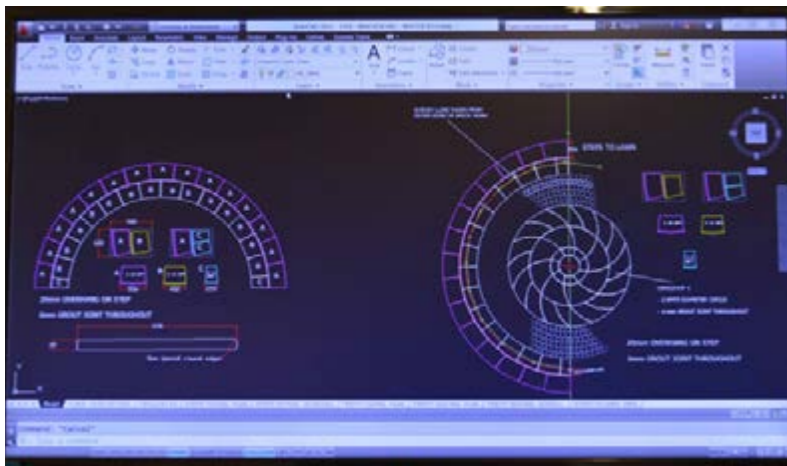
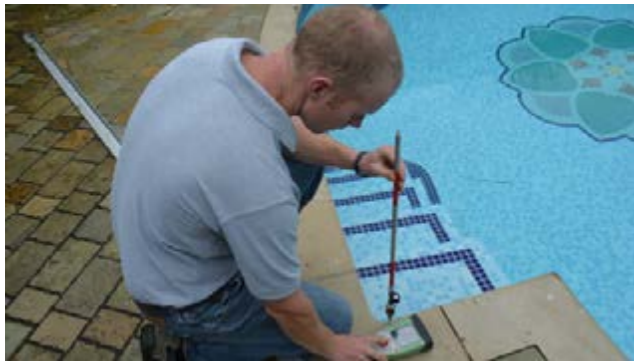

Our In-House Bespoke Works

Our in-house CNC 5-Axis Bridge Saw, Waterjet and profiling machinery allows us to cut and shape stone without limitations.

Working from CAD Drawings and templates we are able to upload drawings and create outstanding pieces of bespoke stone products.

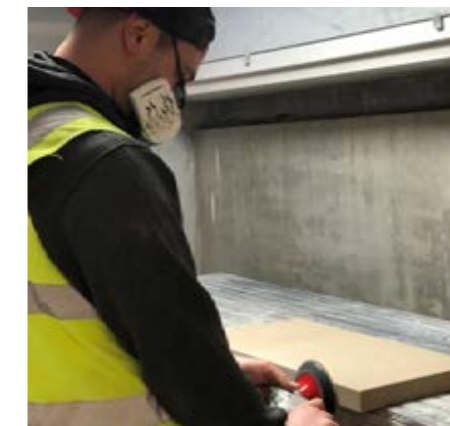

Bespoke Masonry

Having invested heavily in hi-tech computerised machinery, we are able to produce unique and individual stone and porcelain products for any pool or landscaping project.



Freeform Granite Coping



Freeform Marble Coping

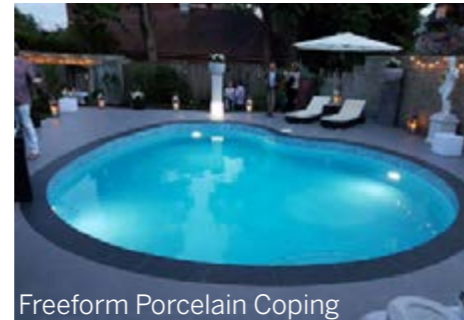

Freeform Porcelain Coping



Radius Spa Bullnosed Coping



Inspection Lid



Limestone Curved Staircase

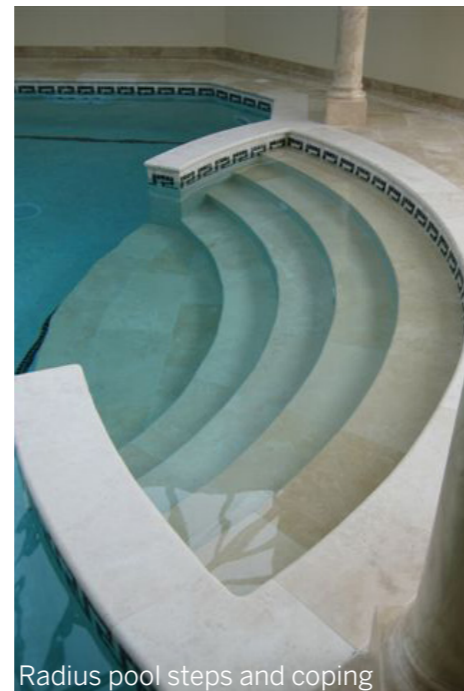

Radius pool steps and coping



Limestone Curved Staircase



Freeform Porcelain Coping

Landscapers and Designers

Although initially our market was predominantly swimming pool surrounds, we are very pleased to be working with landscapers, designers and general builders supplying a wonderful range of natural stone and 20mm thick porcelain paving for landscapes nationwide.

Utilising our investment in hi-tech machinery we are able to help create wonderful bespoke landscaping products, including radius step treads and risers, pier caps, wall capping and much more.

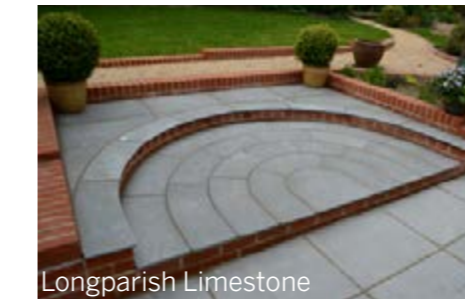

Longparish Limestone



Fossil Pearl Satin Limestone



Farley Black Limestone

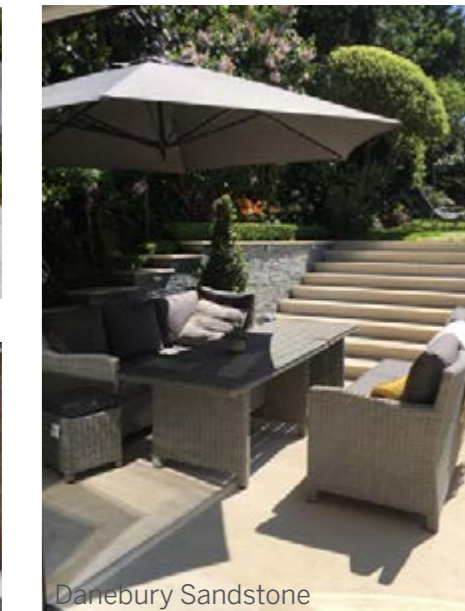

Danebury Sandstone



Leckford Sandstone



Meon Quartz Porcelain

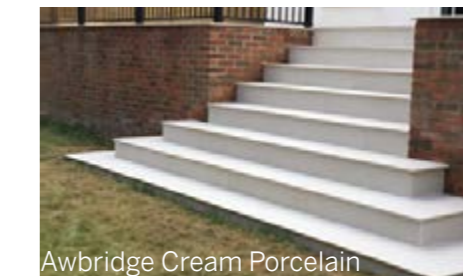

Awbridge Cream Porcelain



Waterford Cream Porcelain



Fossil Pearl Satin Limestone



Leckford Sandstone

Laying Guidelines for Porcelain

Preparation for External Areas:

Decide where the paving is to be laid and mark or peg out clearly. Dig out a little wider than the planned project width, allowing an extra 50mm-75mm at the edges to make handling much easier. Bear in mind that any paving surfaces should be at least 150mm below any damp proof course and should have a 1:60 fall away from the building for surface drainage. Remember to remove all weeds and other unwanted organic matter.

Sub-Base

The depth of the dig and the necessity for a sub-base will depend on the intended use and ground conditions.

If a sub-base is required the depth should be approximately 170mm minimum. This will allow for:

- 100mm compacted hardcore or crushed stone with extra care being taken to ensure any soft spots are identified, dugout and filled.
- 50mm bedding mortar
- 20mm tile

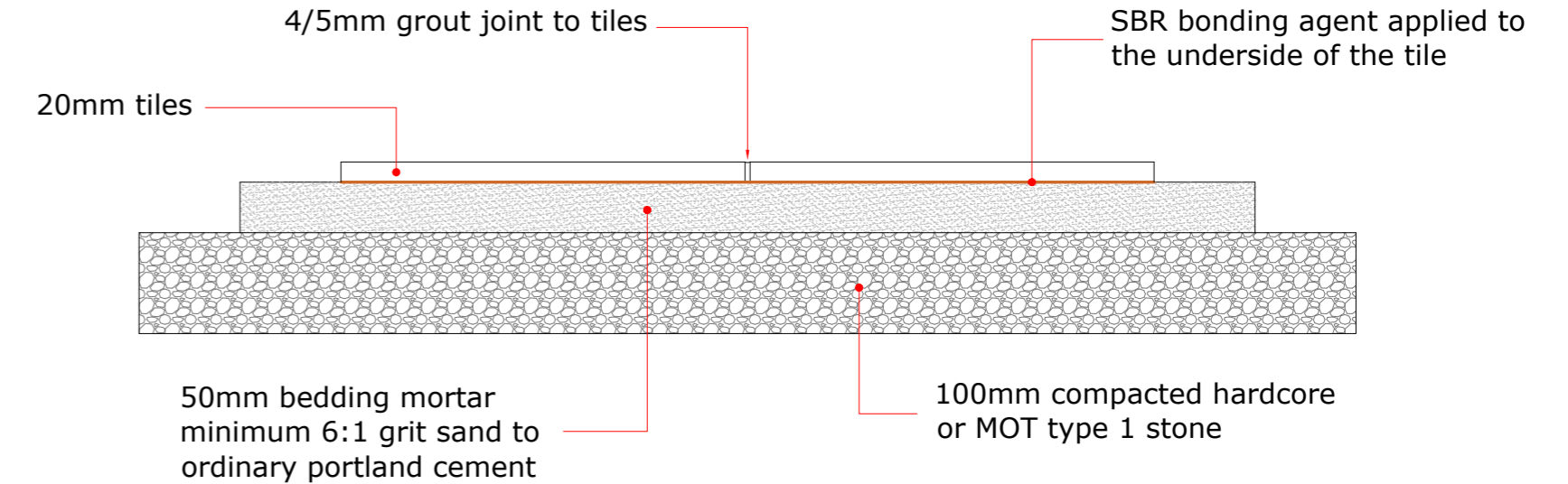

20mm Porcelain: Bedding

Carefully place the tiles onto a levelled out bed of standard sand/ cement, mortar prepared to a wet consistency (slump of 50mm or more) the mortar bed needs to be a 6:1 or stronger mix of grit sand with ordinary Portland cement (OPC). We would recommend 30-50mm of the bedding mortar to be laid over the prepared sub-base and then spreading an SBR bonding agent to the underside of the porcelain tile to aid adhesion.

20mm Porcelain: Laying

Where possible start with full slabs being laid adjacent to a fixed point such as building or edging. Set the required level using a taut line. Tap each slab down to the appropriate level using a rubber mallet and also use a spirit level to double check levels with the adjacent slabs, being careful to maintain 4-5mm joints between the slabs. We would recommend using an external grade tiling grout in-between the joints. Ensure the grout residue is washed off completely (refer to grout manufacturer's recommendations for correct installation procedures).

Laying Guidelines for Natural Stone

In this section we are outlining the principle considerations for laying natural paving. However each project will have its own individual considerations and the advice of a professional should always be sought.

Preparation

Decide where the paving is to be laid and mark or peg out clearly. Dig out a little wider than the planned project width allowing an extra 50mm – 75mm at the edges to make handling much easier.

Bear in mind that any paving surfaces should be at least 150mm below any damp proof course and should have a 1:60 fall away from the building for surface drainage. Remember to remove all weeds and other unwanted organic matter.

Sub-Base

The depth of the dig and the necessity for a sub-base will depend on the intended use and ground conditions. If a sub-base is required the depth should be approximately 190mm minimum.

This will allow for:

- 100mm compacted hardcore or crushed stone with extra care being taken to ensure any soft spots are identified, dug out and filled.
- 50mm bedding mortar
- 25mm – 40mm slab depth

If a sub-base is not required, dig to 90mm. If elevating to a higher level then the elevation should be constructed by adding to the sub-base layer not by increasing the thickness of the bedding layer.

Driveways will always require a sub-base made up of 100mm 'MOT' Type 1 hardcore so the dig will always be 190mm minimum.

Bedding

Depending on preference, the paving may be bedded onto either a full concrete bed (136 or St1 mix), or alternatively a 50mm (compacted depth) bed of sand, gravel and cement (6 parts 5mm – 6mm gravel, 4 parts sharp sand NOT BUILDING SAND and 1 part ordinary Portland cement) – which should be spread to the area and compacted with a couple of passes of a plate compacter prior to bed preparation. The top 15mm – 25mm of the bed should be loosened / rippled to ease levelling as the natural slabs vary in depth. We would also recommend applying an SBR bonding agent to the underside of the lighter coloured sandstone and limestones, to eliminate any moisture patches appearing on the face of the stone.

Laying

Natural stone products have variation in colour so select paving from a number of open packs to ensure an even blend. Where possible start with full flags being laid adjacent to a fixed point such as building or edging. Set the required level using a taut line. Tap each slab down to the appropriate level using a rubber mallet and also use a spirit level to double check levels with the adjacent slabs. It can be helpful to 'butter' the edges of previous slabs – being careful to maintain 10mm – 15mm between the slabs. To butter the previous slabs – trowel mortar onto their edges so that when the next slab is offered up, the mortar compresses and rises up between the slabs to form a joint that can be easily pointed.

Efflorescence

Efflorescence is a natural phenomenon and can occur in all natural paving products. It shows as white patches on the surface of the slabs. The efflorescence may occur each time the paving dries after rain. This may re-occur for up to 18 to 24 months. Efflorescence will cease as the calcium carbonate completely leaves the stone.

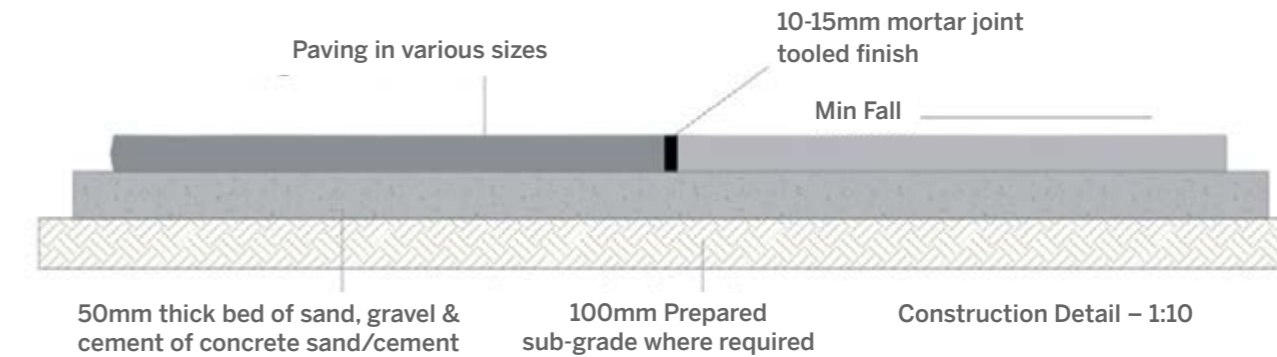

Option 1 Fossil pearl 20mm paving for external application

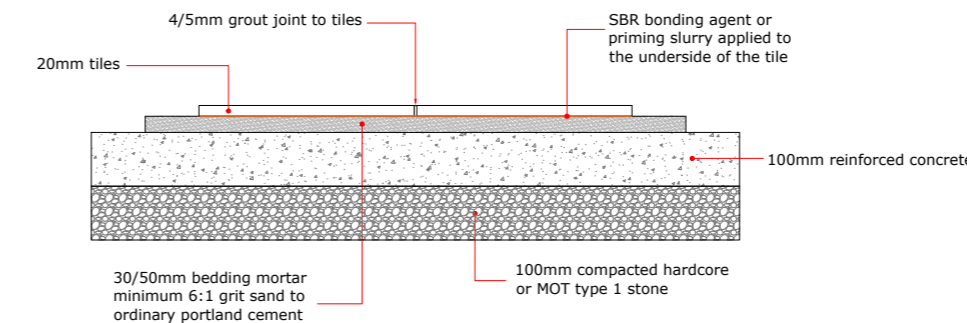

Option 2 Fossil pearl 20mm paving for external application

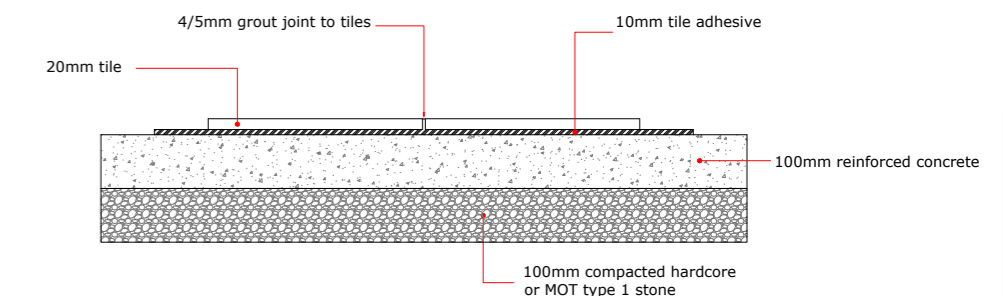

Overlap Coping Installation Guidelines

Coping installation for a fibreglass one peice pool

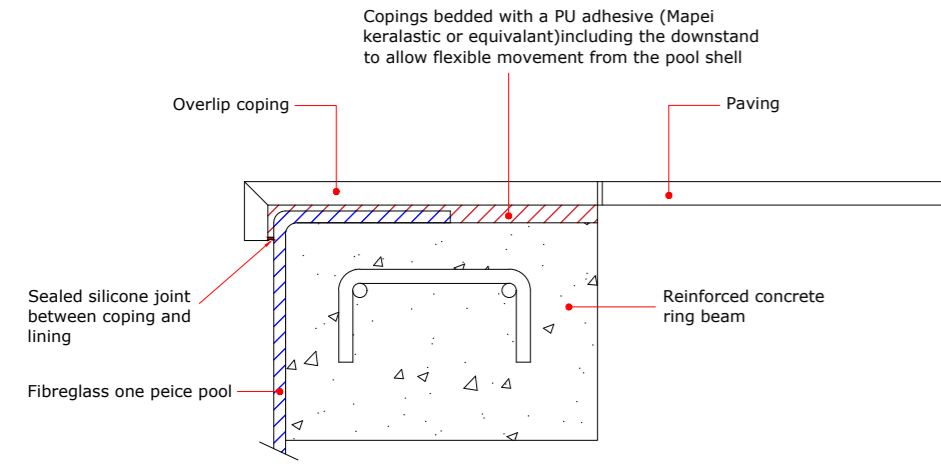

Coping installation for a tiled or liner pool

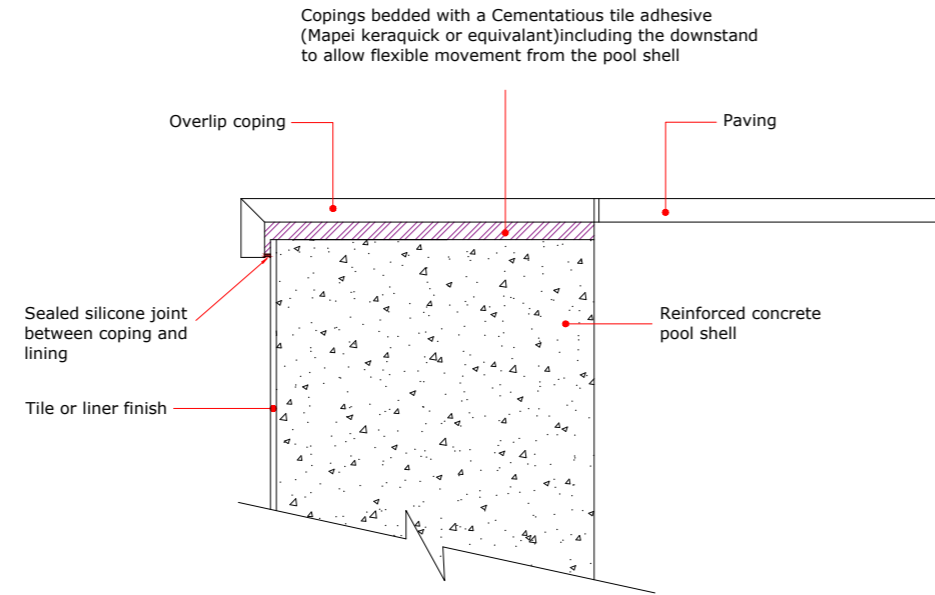

Pack Types

Mixed Paving Pack 600 Series

This pack contains our 4 most popular sizes (as detailed). The mixed pack is perfectly suitable for all projects whether large or small – always maintaining attractive proportions.

The sizes within the packs enable a variety of random patterns (coverage 16.74m²).

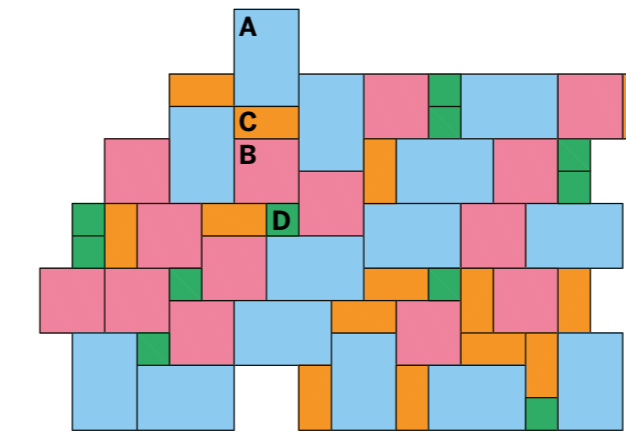

- A** 900 x 600mm – 14pcs
- B** 600 x 600mm – 14pcs
- C** 600 x 290mm – 14pcs
- D** 290 x 290mm – 11pcs

All sizes are nominal.
We recommend a 10-15mm grout joint.

Heritage Mixed Pack

To compliment our Danebury Natural Stone Coping, we have developed the Heritage mixed paving pack, which provides an easy to lay, attractive repeating modular pattern in one convenient pack.

Each 16.08m² Heritage mixed pack (coverage 16.98m²) has 5 modules per pack.

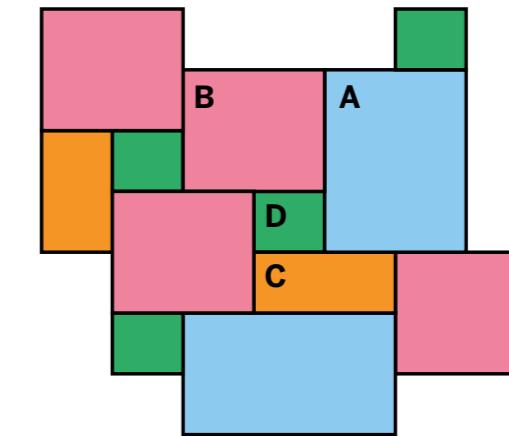

- A** 900 x 600 x 25mm – 10pcs
- B** 600 x 600 x 25mm – 20pcs
- C** 600 x 300 x 25mm – 10pcs
- D** 295 x 295 x 25mm – 20pcs

(5 modules per pack)
All sizes are nominal.
We recommend a 10-15mm grout joint.

Mixed Paving Pack 600 Series

Available in Raj Sandstone. This pack contains 4 sizes (as detailed). The mixed pack is suitable for large and small projects.

(Coverage is 20.7m²)

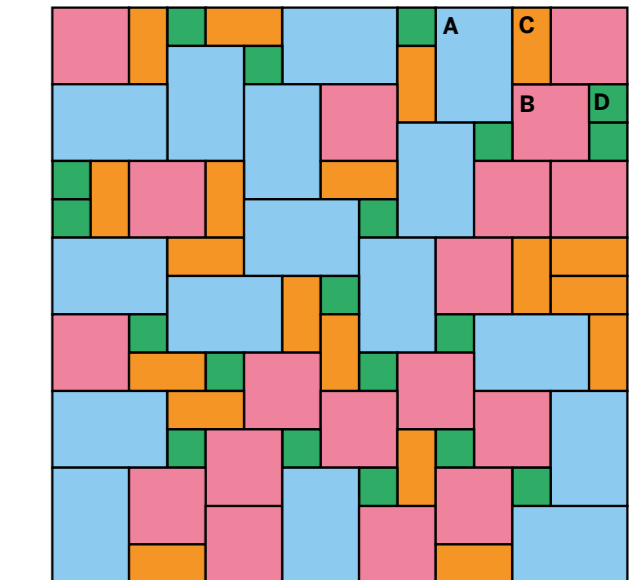

- A** 600 x 900 – 17pcs
- B** 600 x 600 – 17pcs
- C** 600 x 290 – 18 pcs
- D** 290 x 290 – 19 pcs

All sizes are nominal.
We recommend a 1-15mm grout joint.

Terms and Conditions

- 1 INTERPRETATION**
- 1.1 Definitions:**
- Business Day a day other than a Saturday, Sunday or public holiday in England, when banks in London are open for business.
- Conditions the terms and conditions set out in this document as amended from time to time in accordance with clause 11.4.
- Contract the contract between the Supplier and the Customer for the sale and purchase of the Goods in accordance with these Conditions and including the latest edition of Supplier's Delivery Conditions.
- Customer the person or firm who purchases the Goods from the Supplier.
- Delivery Conditions the Suppliers terms and conditions for delivering the Goods, which form part of the Contract PROVIDED THAT if there is any conflict between these Conditions and the Delivery Conditions these Conditions supersede and prevail.
- Delivery Location has the meaning given in clause 4.2.
- Force Majeure Event an event, circumstance or cause beyond a party's reasonable control.
- Goods the goods (or any part of them) set out in the Order.
- Order the Customer's order for the Goods, as set out in the Customer's purchase order form **OR** overleaf **OR** in the Customer's written acceptance of the Supplier's quotation **OR** the Customer's order by email as the case may be.
- Specification any specification for the Goods, including any related plans drawings, professional advice, properties suitable for the application (including but not limited to the strength, slip rating and/or resistance to staining and wear), site surveys, fitting services and free issue cutting that is specifically agreed in writing by the Customer and the Supplier. Notwithstanding any other provision it is the Customers obligation to ensure that the Goods they order are fit for their particular purpose.
- Supplier Cranbourne Stone Limited (registered in England and Wales with company number 05027006).
- 1.2 Interpretation:**
- 1.2.1 A **person** includes a natural person, corporate or unincorporated body (whether or not having separate legal personality).
- 1.2.2 A reference to a party includes its personal representatives, successors and permitted assigns.
- 1.2.3 A reference to legislation or a legislative provision is a reference to it as amended or re-enacted. A reference to legislation or a legislative provision includes all subordinate legislation made under that legislation or legislative provision.
- 1.2.4 Any words following the terms including, **include, in particular, for example** or any similar expression shall be construed as illustrative and shall not limit the sense of the words, description, definition, phrase or term preceding those terms.
- 1.2.5 A reference to **writing** or **written** includes email.
- 2 BASIS OF CONTRACT**
- 2.1 These Conditions apply to the Contract to the exclusion of any other terms that the Customer seeks to impose or incorporate, or which are implied by law, trade custom, practice or course of dealing.
- 2.2 The Order constitutes an offer by the Customer to purchase the Goods in accordance with these Conditions. The Customer is responsible for ensuring that the terms of the Order and any applicable Specification are complete, accurate and suitable for their requirements.
- 2.3 The Order shall only be deemed to be accepted when the Supplier issues a written acceptance of the Order, at which point the Contract shall come into existence.
- 2.4 The Customer waives any right it might otherwise have to rely on any term endorsed upon, delivered with or contained in any documents of the Customer that is inconsistent with these Conditions.
- 2.5 Any samples, drawings, descriptive matter or advertising produced by the Supplier and any descriptions or illustrations contained in the Supplier's catalogues or brochures are produced for the sole purpose of giving an approximate idea of the Goods referred to in them. They shall not form part of the Contract nor have any contractual force.
- 2.6 A quotation for the Goods given by the Supplier shall not constitute an offer. A quotation shall only be valid for a period of 20 Business Days from its date of issue. The Supplier reserves the right to add to any quotation or price for the Goods any shipping surcharge that it is subject to.
- 3 GOODS**
- 3.1 The Goods are described in the Supplier's catalogue and or any Specification that is specifically agreed in writing between the Customer and Supplier.
- 3.2 To the extent that the Goods are to be manufactured in accordance with a Specification supplied by the Customer, the Customer shall indemnify the Supplier against all liabilities, costs, expenses, damages and losses (including any direct, indirect or consequential losses, loss of profit, loss of reputation and all interest, penalties and legal and other professional costs and expenses) suffered or incurred by the Supplier in connection with any claim made against the Supplier for the fitness for purpose of the Goods and or the actual or alleged infringement of a third party's intellectual property rights arising out of or in connection with the Supplier's use of the Specification. This clause 3.2 shall survive termination of the Contract.
- 3.3 The Supplier reserves the right to amend the general specification of the Goods and or any part of the Specification if required by any applicable statutory or regulatory requirement, and the Supplier shall notify the Customer in any such event.
- 4 DELIVERY**
- 4.1 The Supplier shall endeavour to ensure that:
- 4.1.1 each delivery of the Goods is accompanied by a delivery note that shows the date of the Order, the type and quantity of the Goods, special storage instructions (if any) and, if the Goods are being delivered by instalments, the outstanding balance of Goods remaining to be delivered; and
- 4.1.2 if the Supplier requires the Customer to return any packaging materials to the Supplier, that fact is clearly stated on the delivery note. The Customer shall make any such packaging materials available for collection at such times as the Supplier shall reasonably request. Returns of packaging materials shall be at the Supplier's expense.
- 4.2 The Supplier shall subject to the Suppliers Delivery Conditions deliver the Goods to the location set out in the Order or such other location as the parties may agree (Delivery Location) at any time after the Supplier notifies the Customer that the Goods are ready.
- 4.3 Delivery is completed on the completion of unloading of the Goods at the Delivery Location.
- 4.4 Any dates quoted for delivery are approximate only, and the time of delivery is not of the essence. The Supplier shall not be liable for any delay in delivery of the Goods that is caused by a Force Majeure Event or the Customer's failure to provide the Supplier with adequate delivery instructions or any other instructions that are relevant to the supply of the Goods.

- 4.5 If the Supplier fails to deliver the Goods, its liability shall be limited to the costs and expenses incurred by the Customer in obtaining replacement goods of similar description and quality in the cheapest market available, less the price of the Goods. The Supplier shall have no liability for any failure to deliver the Goods to the extent that such failure is caused by a Force Majeure Event or the Customer's failure to provide the Supplier with adequate delivery instructions or any other instructions that are relevant to the supply of the Goods.
- 4.6 Unless otherwise agreed if the Customer fails to take **OR** accept delivery of the Goods within three Business Days of the Supplier notifying the Customer that the Goods are ready, then, except where such failure or delay is caused by a Force Majeure Event or the Supplier's failure to comply with its obligations under the Contract in respect of the Goods:
- 4.6.1 delivery of the Goods shall be deemed to have been completed at 9.00 am on the third Business Day after the day on which the Supplier notified the Customer that the Goods were ready; and
- 4.6.2 the Supplier shall store the Goods until delivery takes place, and charge the Customer for all related costs and expenses (including insurance).
- 4.7 If ten Business Days after the day on which the Supplier notified the Customer that the Goods were ready for delivery the Customer has still not taken **OR** accepted actual delivery of them, the Supplier may charge the sum of £50/week to continue to store the goods or may resell or otherwise dispose of part or all of the Goods and, after deducting reasonable storage and selling costs, account to the Customer for any excess over the price of the Goods or charge the Customer for any shortfall below the price of the Goods.
- 4.8 If the Supplier delivers up to and including 5% more or less than the quantity of Goods ordered the Customer may not reject them, but on receipt of notice from the Customer that the wrong quantity of Goods was delivered, the Supplier shall make a pro rata adjustment to the invoice for the Goods.
- 4.9 The Supplier may deliver the Goods by instalments, which shall be invoiced and paid for separately. Each instalment shall constitute a separate contract. Any delay in delivery or defect in an instalment shall not entitle the Customer to cancel any other instalment.
- 5 QUALITY**
- 5.1 The Supplier warrants that on delivery, and for a period of 12 months from the date of delivery (warranty period), the Goods shall:
- 5.1.1 conform in all material respects with the Specification; and
- 5.1.2 be free from material defects in design, material and workmanship; and
- 5.1.3 be of satisfactory quality (within the meaning of the Sale of Goods Act 1979); and
- 5.1.4 be fit for any purpose held out by the Supplier and agreed in writing with the Customer PROVIDED THAT the Goods may be affected by natural substances (including but not limited to moss or algae) if not cleaned regularly and satisfactorily by the Customer.
- 5.2 Subject to clause 5.3, if:
- 5.2.1 the Customer gives notice in writing to the Supplier during the warranty period within a reasonable time of discovery that some or all of the Goods do not comply with the warranty set out in clause 5.1;
- 5.2.2 the Supplier is given a reasonable opportunity of examining such Goods; and
- 5.2.3 the Customer (if asked to do so by the Supplier) returns such Goods to the Supplier's place of business, the cost to be shared equally between the Customer and Supplier, the Supplier shall, at its option, repair or replace any defective Goods, or refund the price of the defective Goods in full.
- 5.3 The Supplier shall not be liable for the Goods' failure to comply with the warranty set out in clause 5.1 if:
- 5.3.1 the Customer makes any further use of such Goods after giving notice in accordance with clause 5.2;
- 5.3.2 the defect arises because the Customer failed to follow the Supplier's oral or written instructions as to the storage, commissioning, installation, use and maintenance of the Goods or (if there are none) good trade practice regarding the same;
- 5.3.3 the defect arises as a result of the Supplier following any drawing, design or Specification supplied by the Customer;
- 5.3.4 the Customer alters or repairs such Goods without the written consent of the Supplier;
- 5.3.5 the defect arises as a result of fair wear and tear, wilful damage, negligence, or abnormal storage or working conditions; or
- 5.3.6 the Goods differ from their description and **OR** the Specification as a result of changes made to ensure they comply with applicable statutory or regulatory requirements.
- 5.4 Except as provided in this clause 5, the Supplier shall have no liability to the Customer in respect of the Goods' failure to comply with the warranty set out in clause 5.1.
- 5.5 The terms implied by sections 13 to 15 of the Sale of Goods Act 1979 are, to the fullest extent permitted by law, excluded from the Contract.
- 5.6 These Conditions shall apply to any repaired or replacement Goods supplied by the Supplier.
- 6 TITLE AND RISK**
- 6.1 The risk in the Goods shall pass to the Customer on completion of delivery.
- 6.2 Title to the Goods shall not pass to the Customer until:
- 6.2.1 the Supplier receives payment in full (in cash or cleared funds) for the Goods and any other goods that the Supplier has supplied to the Customer in respect of which payment has become due, in which case title to the Goods shall pass at the time of payment of all such sums; and
- 6.2.2 the Customer resells the Goods, in which case title to the Goods shall pass to the Customer at the time specified in clause 6.4.
- 6.3 Until title to the Goods has passed to the Customer, the Customer shall:
- 6.3.1 store the Goods separately from all other goods held by the Customer so that they remain readily identifiable as the Supplier's property;
- 6.3.2 not remove, deface or obscure any identifying mark or packaging on or relating to the Goods;
- 6.3.3 maintain the Goods in satisfactory condition and keep them insured against all risks for their full price from the date of delivery;
- 6.3.4 notify the Supplier immediately if it becomes subject to any of the events listed in clause 9.1.2 to clause 9.1.4; and
- 6.3.5 give the Supplier such information as the Supplier may reasonably require from time to time relating to:
- 6.3.5.1 the Goods; and
- 6.3.5.2 the ongoing financial position of the Customer.
- 6.4 Subject to clause 6.5, the Customer may resell or use the Goods in the ordinary course of its business (but not otherwise) before the Supplier receives payment for the Goods. However, if the Customer resells the Goods before that time:
- 6.4.1 it does so as principal and not as the Supplier's agent; and
- 6.4.2 title to the Goods shall pass from the Supplier to the Customer immediately before the time at which resale by the Customer occurs.

- 6.5 At any time before title to the Goods passes to the Customer, the Supplier may:
- 6.5.1 by notice in writing, terminate the Customer's right under clause 6.4 to resell the Goods or use them in the ordinary course of its business; and
- 6.5.2 require the Customer to deliver up all Goods in its possession that have not been resold, or irrevocably incorporated into another product and if the Customer fails to do so promptly, enter any premises of the Customer or of any third party where the Goods are stored in order to recover them.
- 7 PRICE AND PAYMENT**
- 7.1 The price of the Goods shall be the price set out in the Order, or, if no price is quoted, the price set out in the Supplier's published price list in force as at the date of delivery.
- 7.2 The Supplier may, by giving notice to the Customer at any time up to (ninety) 90 Business Days before delivery, increase the price of the Goods to reflect any increase in the cost of the Goods that is due to:
- 7.2.1 any factor beyond the Supplier's control (including foreign exchange fluctuations, increases in taxes and duties, and increases in labour, materials and other manufacturing costs);
- 7.2.2 any request by the Customer to change the delivery date(s), quantities or types of Goods ordered, or the Specification; or
- 7.2.3 any delay caused by any instructions of the Customer or failure of the Customer to give the Supplier adequate or accurate information or instructions.
- 7.3 The price of the Goods:
- 7.3.1 excludes amounts in respect of value added tax (**VAT**), which the Customer shall additionally be liable to pay to the Supplier at the prevailing rate, subject to the receipt of a valid VAT invoice; and
- 7.3.2 excludes the costs and charges of packaging, insurance and transport of the Goods, which shall be invoiced to the Customer.
- 7.4 The Supplier may invoice the Customer for the Goods on or at any time after confirmation of the Order.
- 7.5 The Customer shall pay for the Goods up front and prior to Delivery in the following instalments:-
- 7.5.1 50% upon placing the Order; and
- 7.5.2 the remaining 50% upon the Goods being ready for delivery and prior to the Goods leaving the factory and prior to Delivery.
- 7.5.3 Subject to provision 7.5 above and in any event the Customer shall pay each invoice submitted by the Supplier: within 14 days of the date of the invoice or in accordance with any credit terms agreed by the Supplier and confirmed in writing to the Customer; and in full and in cleared funds to a bank account nominated in writing by the Supplier, and time for payment shall be of the essence of the Contract. If the Customer fails to make a payment due to the Supplier under the Contract by the due date, then, without limiting the Supplier's remedies under clause 9, the Customer shall pay interest on the overdue sum from the due date until payment of the overdue sum, whether before or after judgment. Interest under this clause 0 will accrue each day at 4% a year above the Bank of England's base rate from time to time, but at 4% a year for any period when that base rate is below 0%. All amounts due under the Contract shall be paid in full without any set-off, counterclaim, deduction or withholding (other than any deduction or withholding of tax as required by law).
- 8 LIMITATION OF LIABILITY**
- 8.1 The Supplier has obtained insurance cover in respect of its own legal liability for individual claims not exceeding the total amount paid for the goods per claim. The Customer is responsible for making its own arrangements for the insurance of any excess loss.
- 8.2 The restrictions on liability in this clause 8 apply to every liability arising under or in connection with the Contract including liability in contract, tort (including negligence), misrepresentation, restitution or otherwise.
- 8.3 Nothing in the Contract limits any liability which cannot legally be limited, including liability for:
- 8.3.1 death or personal injury caused by negligence;
- 8.3.2 fraud or fraudulent misrepresentation;
- 8.3.3 breach of the terms implied by section 12 of the Sale of Goods Act 1979; or
- 8.3.4 defective products under the Consumer Protection Act 1987.
- 8.4 Subject to clause 8.3, the Supplier's total liability to the Customer shall not exceed the total amount paid for the goods.
- 8.5 Subject to clause 8.3, the following types of loss are wholly excluded:
- 8.5.1 loss of profits;
- 8.5.2 loss of sales or business;
- 8.5.3 loss of agreements or contracts;
- 8.5.4 loss of anticipated savings;
- 8.5.5 loss of use or corruption of software, data or information;
- 8.5.6 loss of or damage to goodwill; and
- 8.5.7 indirect or consequential loss.
- 8.6 This clause 8 shall survive termination of the Contract.
- 9 TERMINATION**
- 9.1 Without limiting its other rights or remedies, the Supplier may terminate this Contract with immediate effect by giving written notice to the Customer if:
- 9.1.1 the Customer commits a material breach of any term of the Contract and (if such a breach is remediable) fails to remedy that breach within fourteen (14) days of that party being notified in writing to do so;
- 9.1.2 the Customer takes any step or action in connection with its entering administration, provisional liquidation or any composition or arrangement with its creditors (other than in relation to a solvent restructuring), obtaining a moratorium, being wound up (whether voluntarily or by order of the court, unless for the purpose of a solvent restructuring), having a receiver appointed to any of its assets or ceasing to carry on business or, if the step or action is taken in another jurisdiction, in connection with any analogous procedure in the relevant jurisdiction;
- 9.1.3 the Customer suspends, threatens to suspend, ceases or threatens to cease to carry on all or a substantial part of its business; or
- 9.1.4 the Customer's financial position deteriorates so far as to reasonably justify the opinion that its ability to give effect to the terms of the Contract is in jeopardy.
- 9.2 Without limiting its other rights or remedies, the Supplier may suspend provision of the Goods under the Contract or any other contract between the Customer and the Supplier if the Customer becomes subject to any of the events listed in clause 9.1.2 to clause 9.1.4, or the Supplier reasonably believes that the Customer is about to become subject to any of them, or if the Customer fails to pay any amount due under this Contract on the due date for payment.

- 9.3 Without limiting its other rights or remedies, the Supplier may terminate the Contract with immediate effect by giving written notice to the Customer if the Customer fails to pay any amount due under the Contract on the due date for payment.
- 9.4 On termination of the Contract for any reason the Customer shall immediately pay to the Supplier all of the Supplier's outstanding unpaid invoices and interest and, in respect of Goods supplied but for which no invoice has been submitted, the Supplier shall submit an invoice, which shall be payable by the Customer immediately on receipt.
- 9.5 Termination or expiry of the Contract, however arising, shall not affect any of the parties' rights and remedies that have accrued as at termination or expiry, including the right to claim damages in respect of any breach of the Contract which existed at or before the date of termination or expiry.
- 9.6 Any provision of the Contract that expressly or by implication is intended to come into or continue in force on or after termination or expiry of the Contract shall remain in full force and effect.
- 10 FORCE MAJEURE**
- Neither party shall be in breach of the Contract nor liable for delay in performing, or failure to perform, any of its obligations (excluding payment obligations) under the Contract if such delay or failure result from a Force Majeure Event. In such circumstances the time for performance shall be extended by a period equivalent to the period during which performance of the obligation has been delayed or failed to be performed OR the affected party shall be entitled to a reasonable extension of the time for performing such obligations. If the period of delay or non-performance continues for (six) 6 months, the party not affected may terminate the Contract by giving one hundred and twenty (120) days' written notice to the affected party.
- 11 GENERAL**
- 11.1 Assignment and other dealings.
- 11.1.1 The Supplier may at any time assign, transfer, mortgage, charge, subcontract, delegate, declare a trust over or deal in any other manner with all or any of its rights or obligations under the Contract.
- 11.1.2 The Customer may not assign, transfer, mortgage, charge, subcontract, delegate, declare a trust over or deal in any other manner with any or all of its rights or obligations under the Contract without the prior written consent of the Supplier.
- 11.2 Confidentiality.
- 11.2.1 Each party undertakes that it shall not at any time **OR** at any time during the Contract and for a period of two (2) years after termination or expiry of the Contract, disclose to any person any confidential information concerning the business, affairs, customers, clients or suppliers of the other party, except as permitted by clause 11.2.2.
- 11.2.2 Each party may disclose the other party's confidential information:
- 11.2.2.1 to its employees, officers, representatives, contractors, subcontractors or advisers who need to know such information for the purposes of exercising the party's rights or carrying out its obligations under the Contract. Each party shall ensure that its employees, officers, representatives, contractors, subcontractors or advisers to whom it discloses the other party's confidential information comply with this clause 11.2; and
- 11.2.2.2 as may be required by law, a court of competent jurisdiction or any governmental or regulatory authority.
- 11.2.3 Neither party shall use the other party's confidential information for any purpose other than to exercise its rights and perform its obligations under or in connection with the Contract.
- 11.3 Entire agreement.
- 11.3.1 The Contract constitutes the entire agreement between the parties and supersedes and extinguishes all previous agreements, promises, assurances, warranties, representations and understandings between them, whether written or oral, relating to its subject matter.
- 11.3.2 Each party agrees that it shall have no remedies in respect of any statement, representation, assurance or warranty (whether made innocently or negligently) that is not set out in the Contract. Each party agrees that it shall have no claim for innocent or negligent misrepresentation or negligent misstatement based on any statement in the Contract.
- 11.4 Variation. No variation of this Contract shall be effective unless it is in writing and signed by the parties (or their authorised representatives).
- 11.5 Waiver. No failure or delay by a party to exercise any right or remedy provided under the Contract or by law shall constitute a waiver of that or any other right or remedy, nor shall it prevent or restrict the further exercise of that or any other right or remedy. No single or partial exercise of such right or remedy shall prevent or restrict the further exercise of that or any other right or remedy.
- 11.6 Severance. If any provision or part-provision of the Contract is or becomes invalid, illegal or unenforceable, it shall be deemed deleted, but that shall not affect the validity and enforceability of the rest of the Contract. If any provision of the Contract is deemed deleted under this clause 11.6 the parties shall negotiate in good faith to agree a replacement provision that, to the greatest extent possible, achieves the intended commercial result of the original provision.
- 11.7 Notices.
- 11.7.1 Any notice or other material communication given to a party under or in connection with the Contract shall be in writing and shall be delivered by hand or by pre-paid first-class post or other next working day delivery service at its registered office (if a company) or its principal place of business (in any other case).
- 11.7.2 Any notice or other material communication shall be deemed to have been received:
- 11.7.2.1 if delivered by hand, at the time the notice is left at the proper address;
- 11.7.2.2 if sent by pre-paid first-class post or other next working day delivery service, at 9.00 am on the second Business Day after posting; or
- 11.7.2.3 if sent by fax or email, at the time of transmission, or, if this time falls outside business hours in the place of receipt, when business hours resume. In this clause 11.7.2.3, business hours means 9.00am to 5.00pm Monday to Friday on a day that is not a public holiday in the place of receipt.
- 11.7.3 This clause does not apply to the service of any proceedings or other documents in any legal action or, where applicable, any arbitration or other method of dispute resolution.
- 11.7.4 A notice given under the Contract is not valid if sent by email.
- 11.8 Third party rights.
- 11.8.1 Unless it expressly states otherwise, the Contract does not give rise to any rights under the Contracts (Rights of Third Parties) Act 1999 to enforce any term of the Contract.
- 11.8.2 The rights of the parties to rescind or vary the Contract are not subject to the consent of any other person.
- 11.9 Governing law. The Contract, and any dispute or claim (including non-contractual disputes or claims) arising out of or in connection with it or its subject matter or formation, shall be governed by and construed in accordance with the law of England and Wales.
- 11.10 Jurisdiction. Each party irrevocably agrees that the courts of England and Wales shall have exclusive jurisdiction to settle any dispute or claim (including non-contractual disputes or claims) arising out of or in connection with the Contract or its subject matter or formation.

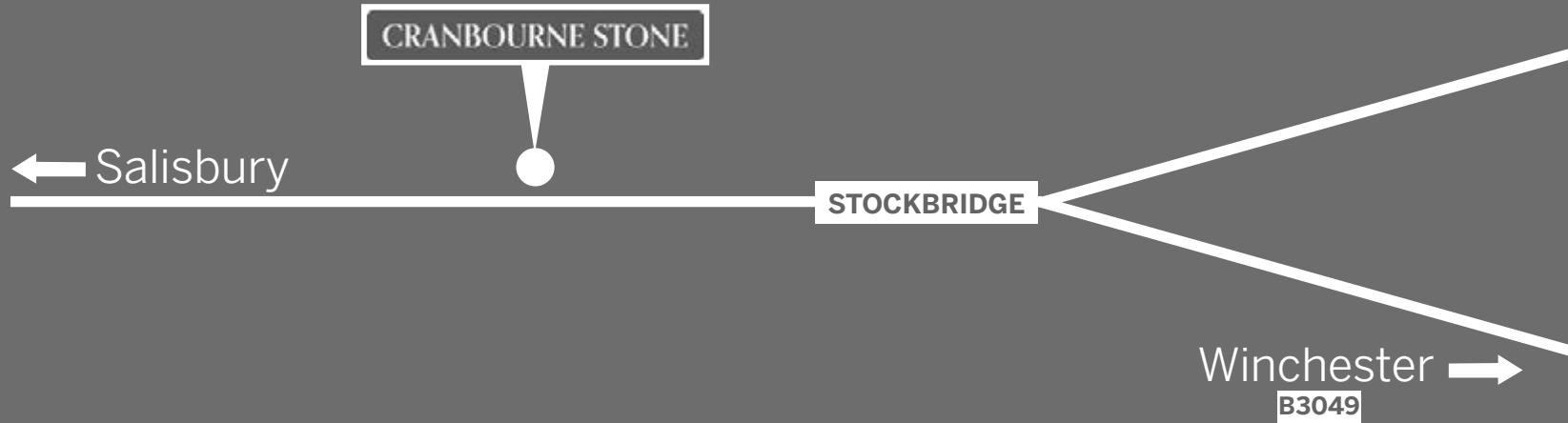

Your Local Stockist is:

Unit 1 • Houghton Down Farm • Stockbridge • Hampshire • SO20 6JR

Tel: 01264 810813 • Email: sales@cranbournestone.co.uk

www.cranbournestone.co.uk



Scan QR code
to go to our
homepage

