



OWNER INSTALLATION MANUAL

I-PAC PRO HEAT PUMP

| en |



1009494

Rev. 1.0 - 2024-W50

Table of contents

Introduction	3
Safety	5
Product description	6
General description	6
Transportation, handling and storage	7
General instructions	7
Enclosure dimensions	8
Overall dimensions	8
Accessories	9
Items supplied with the heat pump	9
Installation	10
Outdoor installation : Positioning and air flow	10
Indoor installation : Positioning and air flow	11
Indoor installation : Fitting the remote control panel	12
General requirements	13
Refrigerant type and installed location	14
Plumbing and pool water circuit	15
Power connection	16
Pool water filter pump synchronisation terminals: P1 and P2	18
Remote on ~ off terminals 5 and 6	19
Initial checks	20
Operation	21
Heat pump control panel	21
Remote control panel	24
Set up	28
Setting up the APP	28
Pairing the App automatically	29
Pairing the App manually	31
App screen	33
Maintenance	34
General maintenance instructions	34
General instructions	35
Heat pump malfunction	36
Protection codes	37
Fault codes	38
Annex	39
Technical data sheet: single phase heat pumps	39
Technical data sheet : three phase heat pumps	40
Electrolytic corrosion in swimming pools	41
Winterisation procedure	42
Start up after winterisation procedure	43
Warranty	44
Terms and conditions	44
Reporting Security Vulnerabilities	45
Procedure	45
Spare parts and accessories ordering process	45
Declaration of conformity (CE)	46
Statement of compliance	48

Introduction

Overview

This is the manual for the I-PAC PRO range of heat pumps.
The part number of these operating and service instructions is 1009494 and applies to units with serial numbers from: 82812xxxx240407001.

Models

Dantherm no.	Model
1009277	I-PAC PRO 10A
1009271	I-PAC PRO 16A
1009272	I-PAC PRO 22A
1009273	I-PAC PRO 22B
1009274	I-PAC PRO 28A
1009275	I-PAC PRO 28B
1009276	I-PAC PRO 36B

User groups

User groups for these operating and service instructions are:

- Operators using the unit as intended.
- Qualified personnel (e.g. refrigeration technicians, installers, service technicians) who properly install and maintain the unit.

Copyright

No part of this manual may be reproduced without the prior written permission of Dantherm Group.

Recycling

This unit is designed to provide a long service life. At the end of its service life, the unit must be recycled in accordance with national regulations and with high environmental protection considerations.

Reservations

Dantherm Group reserves the right to make changes and improvements to the product and the manual at any time without any obligation to give prior notice.

Quality Management System

Dantherm Group has implemented a quality management system in accordance with EN/ISO9001. The system is supplemented with an environmental management system in accordance with EN/ISO14001.

Symbols used in the operating instructions

In these operating instructions, particularly important text passages are highlighted with signal words and symbols that are described below.

DANGER

...indicates a hazard which, if not avoided, will result in death or serious injury.

WARNING

...indicates a hazard which, if not avoided, could result in death or serious injury.

CAUTION

...indicates a hazard which, if not avoided, could result in a minor or moderate injury.

NOTICE

...indicates important information (e.g. property damage) but does not indicate hazards.

INFO

...information marked with this symbol helps you to carry out your tasks quickly and safely.

Hazard symbols



This symbol is used to warn you of potential risk of injuries. Follow all safety instructions indicated in the manual next to the warning triangle to avoid potential injury or death.



Electrical voltage
This symbol indicates that there are dangers to the life and health of persons due to electrical voltage when handling the system.



Protective gloves
This symbol indicates that it is required to wear protective gloves when performing a specific operation.



Protective mask
This symbol indicates that it is required to wear a protective mask when performing a specific operation.

Safety



Note! Read carefully before use. Keep for future reference.

It is the responsibility of the operator to read and understand this manual and other information provided and to apply the correct operating procedures.

Read the entire manual before starting up the unit for the first time. It is important to be familiar with the correct operating procedures for the unit and all related safety precautions to avoid the risk of personal injury and/or property damage.

Safety instructions



The following safety instructions must be observed:

- Ensure that all electric cables outside of the unit are protected from damage (e.g. caused by animals). Never use the unit if electric cables or the power connection are damaged!
- Only install the unit in accordance with the national regulations for electrical connection.
- Before carrying out maintenance, care or repair work on the unit, ensure the heat pump is switched off and isolate from the mains power supply.
- Observe the operating conditions specified in the section titled **Technical data sheet**.
- Check accessories and connection parts for possible damage prior to every use of the unit. Do not use any defective units or unit parts.
- Do not use the unit in potentially explosive rooms or areas and do not install it there.
- The unit shall be stored, installed and operated in a room with a floor area larger than stated in the table contained in the section titled **Refrigerant type and installed location**.
- Do not cover any air intakes or outlets at any point, except with accessories intended for this purpose.
- Never immerse the device in water.
- Do not pierce or burn.

Any operation other than as described in this manual is prohibited. Non-observance renders all claims for liability and guarantee null and void.

If any unauthorised modifications are made, any claims for liability and guarantee are rendered null and void.

These units must only be operated by qualified (trained) personnel and repair of the refrigeration circuit and the electrical system is to be performed by qualified personnel only. Failure to do so may result in personal injury or damage to the equipment.

Stage of life	Activity	Target group
Installation		Qualified personnel
Operation		Operating personnel
Maintenance	General maintenance activities	Operating personnel
	Repair activities	Qualified personnel

Dantherm Group offers training on installation, operation and maintenance activities. Contact information can be found on the back page.

Product description

General description

This heat pump utilises the latest technology to provide a reliable and energy efficient method to heat or cool your swimming pool in an environmentally friendly way. Manufactured from high quality materials the heat pump has a range of advanced features.

- Stepless DC twin rotary inverter compressor
- DC brushless fan motor
- All season operating range from -20°C to 43°C
- Quiet operation
- Electronic expansion valve (EEV) technology
- Reverse cycle rapid defrosting utilising a four way valve
- High efficiency twisted titanium heat exchanger
- High and low pressure protection
- Fully protected electrical system with in-built fault reporting
- Can be operated remotely using the dedicated Pooltherm App

The heat pump has three modes of operation.

The maximum capacity in any mode will be influenced by the conditions.

Mode	Operating feature
Turbo mode	Heating capacity range : 100% to 20% Provides fast heating
Perfect mode	Heating capacity range : 80% to 20% Automatic adjustment according to the ambient air and pool water temperatures with intelligent optimization Provides high efficiency and energy savings
Silence mode	Heating capacity range : 50% to 20% Ideal for operating when low noise levels are desirable

It is important that the heat pump is correctly sized for the application as the heating performance will reduce as the air temperature falls which may result in difficulty fully heating the pool when the ambient air temperature is 10°C or less.

Transportation, handling and storage

General instructions

Take care when handling the heat pump to ensure no damage is caused which may result in a refrigerant leak.

Always keep the heat pump upright.

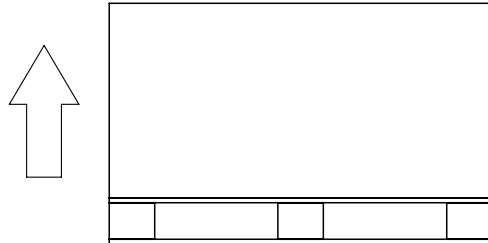

Never lift the heat pump using the water inlet and outlet connectors as this may damage the titanium heat exchanger in the heat pump.

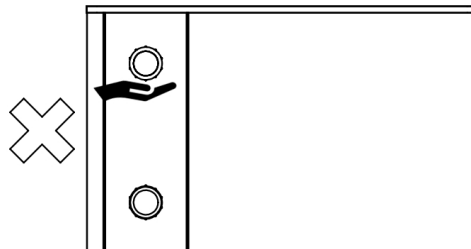

WARNING



Risk of injury due to refrigerant leak.

Toxic fumes may occur in the event of a fire. You must leave the room where the heat pump is stored / located as quickly and safely as possible.

The heat pump must not be stored, located or operated in corrosive environments or locations (rooms) where there are sources of fire or other continuously operating ignition sources such as open flames, operating gas appliances or operating electric heaters.

The heat pump must be stored in a location where the floor area exceeds the minimum area requirements stated in the section titled **Refrigerant type and installed location**.

Do not store combustible gases or liquids near to the heat pump.

CAUTION



Risk of injury due to poor handling or storage.

Stacking the heat pump inappropriately may result in personal injury or damage to the unit.

For storage and transportation purposes the I-PAC PRO 10 and 16 models can be stacked 3 units high. All other models can be stacked 2 units high. When stacking the heat pumps ensure they are located on, and secured to a suitable pallet, and that a suitable device such as an industrial forklift is used to move the consignment.

Always check the packaging for damage and ensure there are no signs of fluid leaks underneath the heat pump when stored.

Enclosure dimensions

Overall dimensions

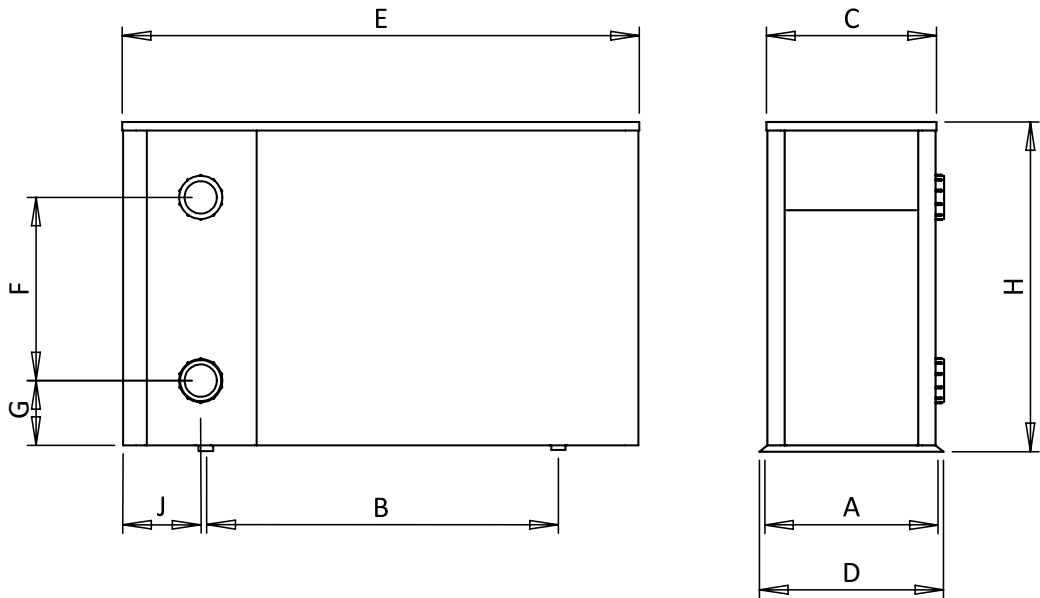

Dimensions (mm)	A	B	C	D	E	F	G	H	J
10A	402	574	390	427	946	340	75	660	108
16A	402	824	390	427	1195	470	75	760	108
22A	511	700	495	536	1071	550	75	953	122
22B	511	700	495	536	1071	550	75	953	122
28A	511	891	495	536	1264	550	75	954	133
28B	511	891	495	536	1264	550	75	954	133
36B	511	991	495	536	1364	670	75	954	133

Accessories: Items supplied with the heat pump

Accessories

Items supplied with the heat pump

Owner installation manual.

Winterisation cover.

Water union connectors.

Two 50mm female and two 48.3mm female.

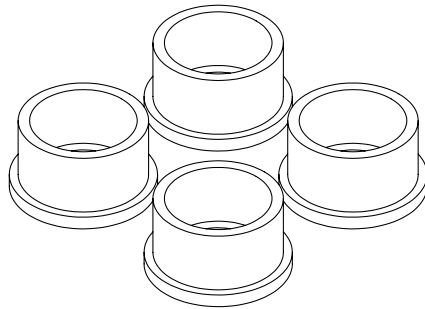

Four rubber anti vibration mounts.

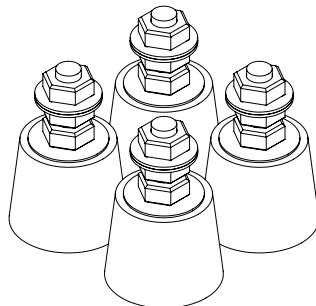

Condensate drainage kit [adaptor plus flexible hose].

The drainage kit should be fitted to the heat pump prior to locating and securing in place.

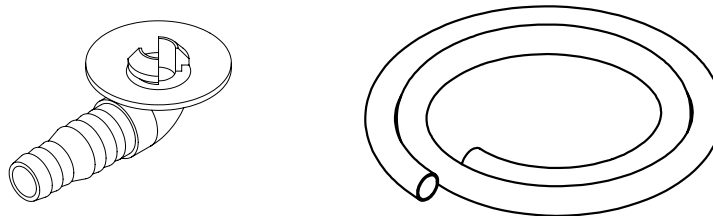

Installation

Outdoor installation : Positioning and air flow

Installation should only be carried out by qualified, competent personnel and must comply with all relevant local or national regulations.

For optimal performance, the heat pump should be installed outdoors in an open area, with as much space as possible between the unit and any potential obstructions. Obstructions include objects such as walls, fences, hedges, or anything that might limit the free movement of air around the unit.

If the heat pump needs to be installed indoors, please refer to the section titled **Indoor Installation** for specific guidelines.

The heat pump functions by absorbing energy from the air passing through it. Any obstruction that restricts airflow will reduce its efficiency. Moreover, obstructions can cause exhaust air to recirculate back into the unit, further diminishing performance.

While it is best to avoid placing the heat pump near obstructions, if it is enclosed on up to two sides with minimum clearances met then the unit should still perform as expected. However, if the heat pump is enclosed on more than two sides—even with minimum clearances—the performance will be reduced. If obstructions are closer than the recommended minimum clearances, the performance will be significantly impacted.

It is also advisable not to place the heat pump under any structure or awning.

For installations involving multiple heat pumps, the minimum clearance must be maintained for each unit. The air inlets and outlets of all heat pumps should be aligned in the same orientation.

The diagram below illustrates the mandatory minimum clearances between the heat pump and any potential obstructions. The heat pump should never be located in the area shaded in orange in the diagram.

To easily mark the radius where two obstructions meet, use a piece of string 1350mm long attached to a peg. Place the peg at the point where the two obstructions intersect, pull the string taut, and trace an arc to mark the radius.

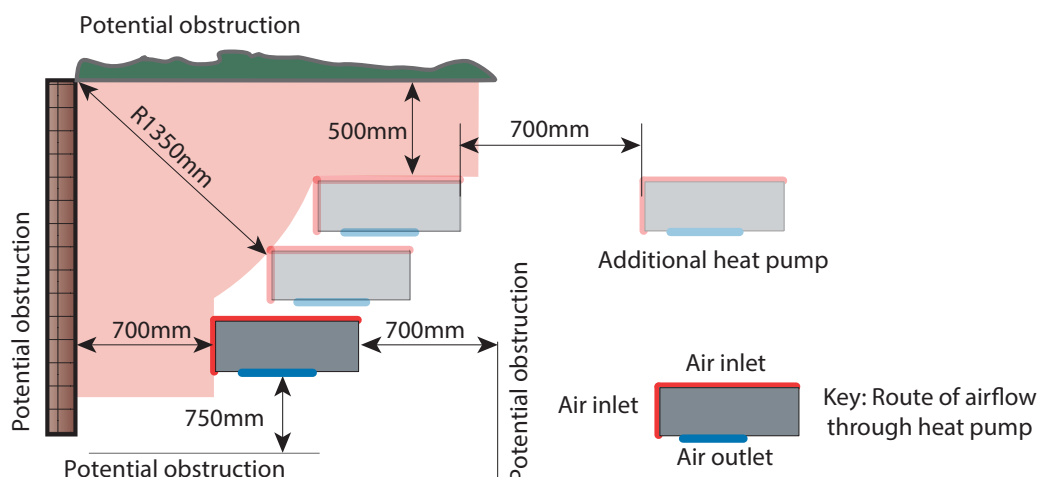

Installation

Indoor installation : Positioning and air flow



Installation should only be carried out by qualified, competent personnel and must comply with all relevant local or national regulations.

If installed in an enclosed area or with exhaust passing through a wall, ensure the minimum required free area for proper airflow.

The diagram below illustrates the mandatory minimum clearances between the heat pump and any potential obstructions. Obstructions may include walls, fences, hedges, or any other object that could impede the free movement of air.

Since the heat pump's controller will be obscured by the wall in such installations, it is recommended to connect to the optional remote control panel or the Pooltherm App before positioning the unit.

To maintain optimal performance, the heat pump must be properly sealed against the wall. This prevents exhaust air from recirculating into the unit, which would otherwise reduce its efficiency. As the exhaust air outlet grille extends around one side of the heat pump, an optional air sealing strip should be installed to assist with sealing this area effectively.

Ensure the wall hole is sealed and smooth to prevent exhaust air from entering cavities and restricting airflow.

The term "free area" refers to the open space through which air can pass freely through grilles or louvres, ensuring adequate ventilation for the heat pump's operation.

Model		10A	16A	22A	22B	28A	28B	36B
Discharge area	m ²	0.45	0.67	0.84	0.84	0.95	0.95	1.04
Hole height	mm	585	685	880	880	880	880	880
Hole width	mm	770	980	955	955	1080	1080	1180

Possible locations for the heat pump relative to a wall or plant room.

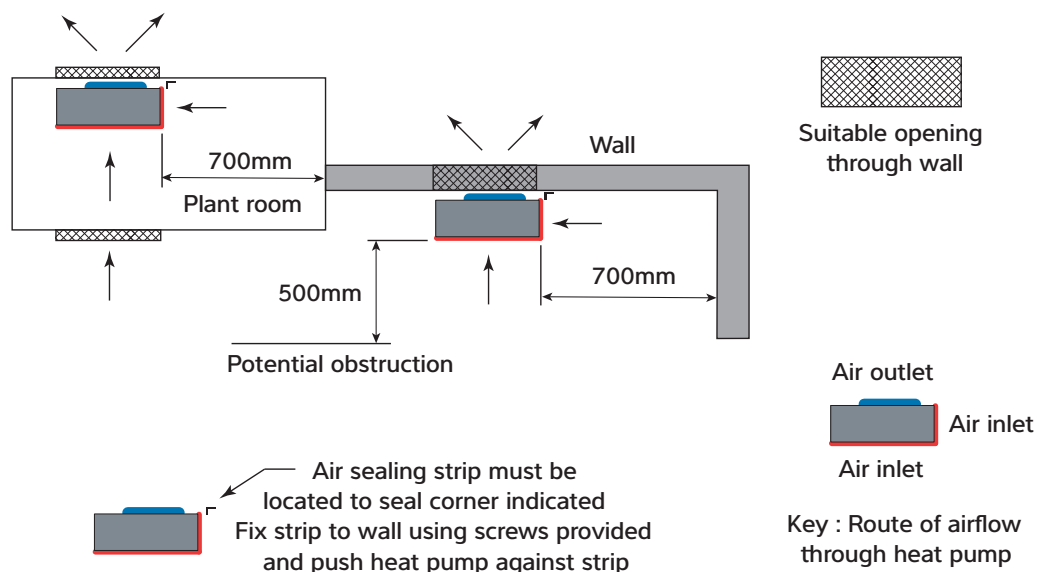

Installation

Indoor installation : Fitting the remote control panel



! DANGER

Risk of electric shock.

Working with the power supply on can result in severe injury. Follow the personnel requirements outlined in the section titled **Safety**. Before starting this procedure, ensure the unit is switched off and disconnected from the mains power supply.

Remove the lower side panel, upper side panel and top cover in order from the heat pump.

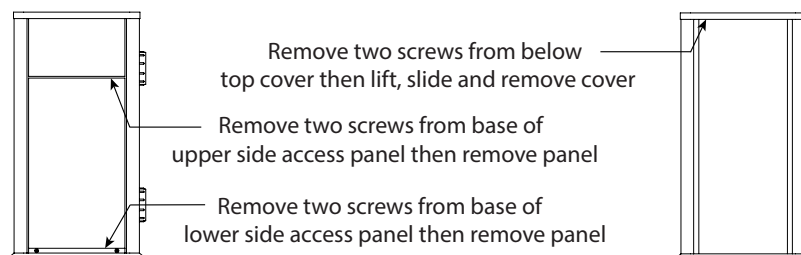

Remove the top cable gland in the heat pump and replace with the supplied grommet.

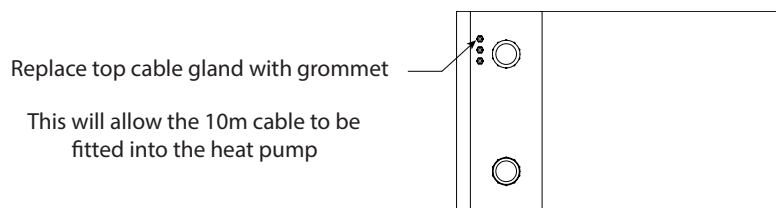

Cut the cable tie and slide back the sleeving on the existing cable (fly lead) to the heat pump control panel to expose the plug and socket, then disconnect them. Feed the appropriate end of the 10m cable for the remote control panel through the new grommet and connect it to the socket on the existing cable inside the heat pump. Route and secure the new cable as needed, leaving the original fly lead from the control panel disconnected. Reposition the sleeving over the plug and socket, and secure it with a new cable tie.

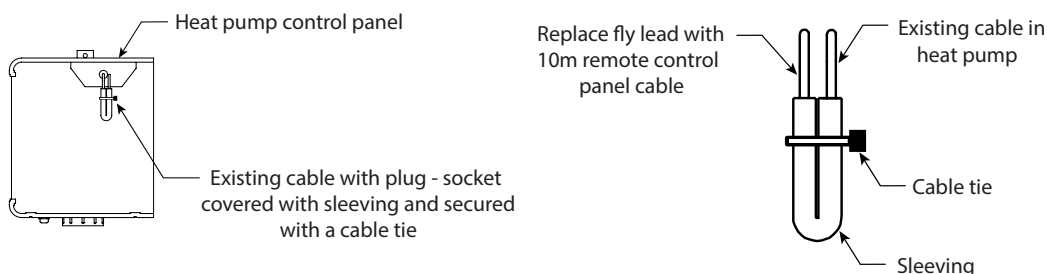

Position the remote control panel mounting box and feed the 10m cable through the appropriate opening. If the cable is concealed within the wall and routed through the rear of the mounting box, use a grommet to protect the cable. Connect the cable to the remote control panel's fly lead, then secure the panel in the mounting box.

The remote control panel is not protected against water ingress and is not weather proof.

Replace the top cover and two side panels on the heat pump and check the remote control panel operates correctly.

Installation

General requirements

During operation, the heat pump will produce condensation that drains from its base. Before securing the heat pump in place, ensure the supplied condensate drainage kit is properly connected and directed to a drain or soak-away.

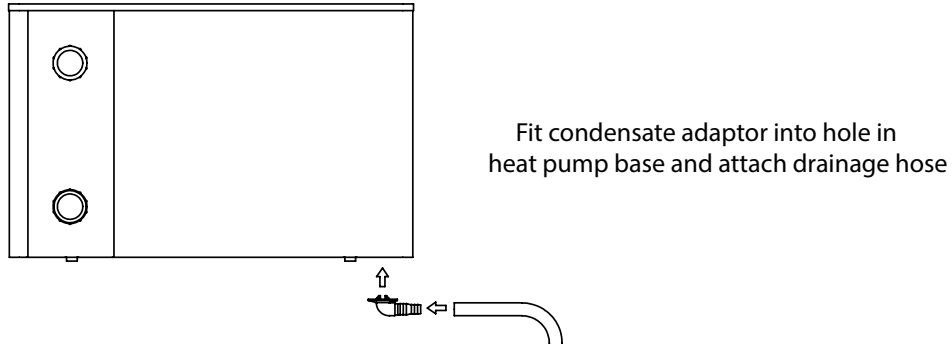

Components are secured to the heat pump base with screws or bolts, and while every effort is made to seal these fittings, small amounts of condensation may still leak through the base.

The heat pump should be mounted using the provided anti-vibration mounts or M10 bolts, either on a level concrete base or securely fixed mounting brackets. Ensure that all fixings and brackets are corrosion-resistant.

NOTICE

Improper heat pump location or installation can lead to reduced performance, resulting in longer pool heating times, failure to reach the desired temperature, and higher energy costs.

WARNING



Risk of electric shock due to incorrect heat pump location.

To meet safety regulations for electrical installations in wet areas, the heat pump must be positioned at least 3.5 meters away from the edge of the pool or spa.

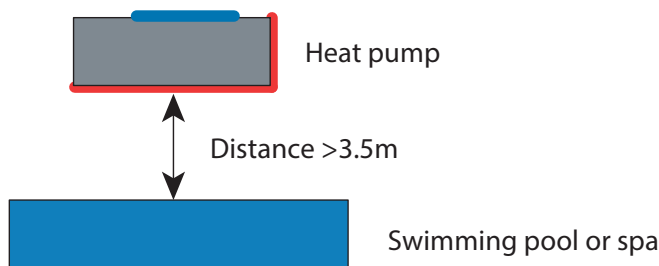

The heat pump uses R32 refrigerant. For safe handling, storage, and installation, please refer to the sections titled **Transportation, Handling, and Storage** as well as **Refrigerant Type and Installed Location** on the following page.

Installation

Refrigerant type and installed location



WARNING

Risk of injury due to refrigerant leak.

This heat pump contains R32, which is an environmentally friendly refrigerant with a Global Warming Potential [GWP] of 675 and has the safety in use classification of A2L, being low toxicity and lower flammability. In practical terms it is very difficult to ignite an A2L refrigerant, but this classification requires a risk assessment to be undertaken for the possibility of accidental release of the refrigerant into the area connected to the heat pump which must consider the application, location of components and the installed refrigerant charge. This installation guidance can form the framework for such a risk assessment for the installation.

Flammable refrigerants will not ignite if the concentration level in a room stays below its Lower Flammability Level [LFL]. European standard EN 378 defines requirements to remain below the LFL in case of accidental leakage. By choosing the location as dictated by EN 378-2:2016 the probability of forming a flammable atmosphere can be eliminated. Please refer to the minimum area for each product and the interpretation that follows regarding the locations of the heat pump and swimming pool. This information is provided as a guide only and does not supersede the regulations or health and safety requirements.

If a refrigerant leak is detected during the installation stop the process immediately and contact the Dantherm Group UK Service Department. Be aware that refrigerants may not contain an odour.

Model		10A	16A	22A	22B	28A	28B	36B
Refrigerant charge	kg	1.25	1.7	2.3	2.4	3.0	3.0	3.6
Minimum area	m ²	13.3	24.6	45	49	76.6	76.6	110.3
* Assumed worse case access category : a [general access] and location class I [mechanical equipment in occupied space] as defined in line with EN 378-1:2016 section 5.1 table 4 and section 5.3. * Minimum area is calculated in line with EN 378-1:2016 section C.2 calculation C.2.								

Interpretation

Refer to the installation situations below for how to apply the minimum area requirements.

Pool outside and heat pump outside :

Automatically meets the minimum area requirement as outside space is unlimited.

Pool outside and heat pump inside a plant room :

Automatically meets the minimum area requirement because the plant room must be open to the outside space for heat pump airflow and outside space is unlimited.

Pool inside and heat pump outside :

The pool hall must exceed the minimum area requirement shown in the table above.

Pool inside and heat pump inside plant room which is isolated from the pool hall :

The pool hall must exceed the minimum area requirement shown in the table above.

Pool inside and heat pump inside plant room which is ventilated to the pool hall :

The pool hall and plant room combined area must exceed the minimum area requirement shown in the above table.

Installation

Plumbing and pool water circuit

Before installing the heat pump ensure the blanking discs are removed from the pool water inlet and outlet connections. These should drop out when the locking rings are unscrewed.

Ensure that a bypass is fitted into the pool water circuit and set to achieve the recommended flow rate stated on the data sheet.

Ensure the condensate drain kit supplied with the heat pump is connected and is directed to a drain or soak-away before fixing the pool water pipework.

The inlet and outlet pool water pipework must be solid pipes (not flexible) and must be supported to prevent excessive strain on the heat pump connections.

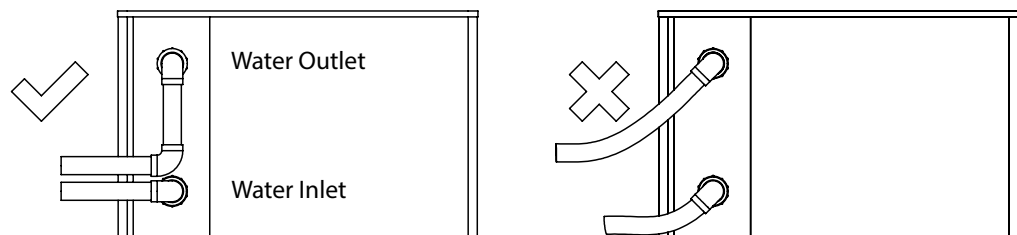

The heating performance can be improved by insulating the pool water pipework and it is recommended that a cover is fitted to the swimming pool to reduce heat losses.

The pool water quality must be maintained as specified in the warranty conditions.

Pool water circuit

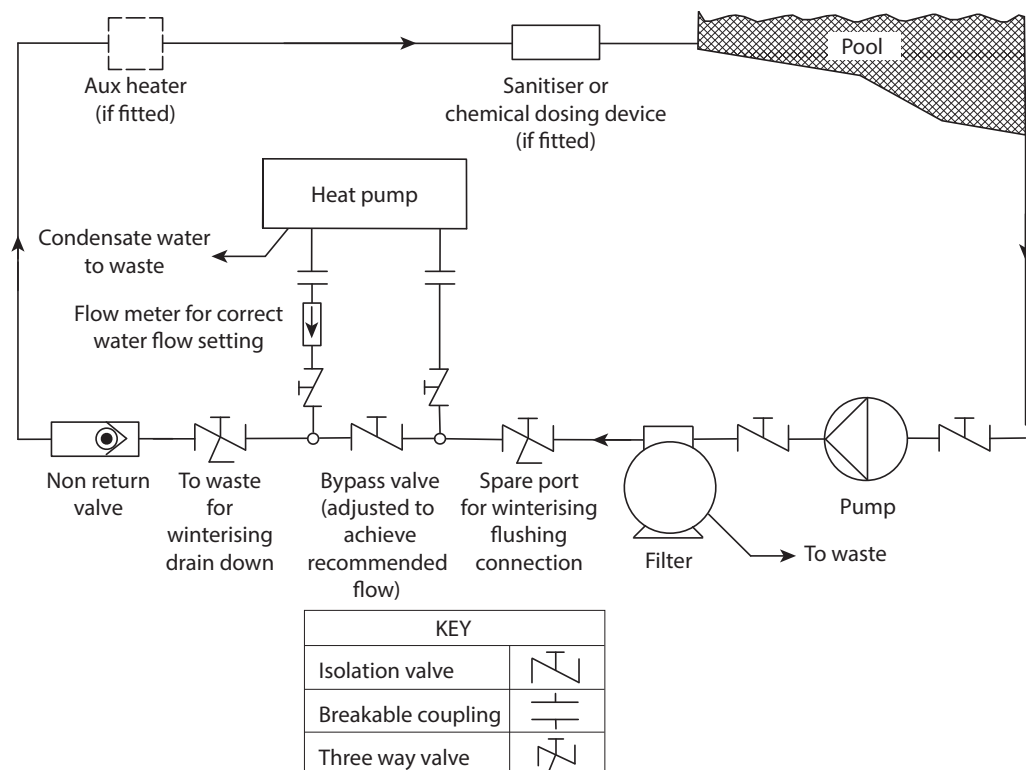

Installation

Power connection



DANGER

Risk of electric shock.

Electric shock can cause serious injury. Ensure the cable you are about to connect is not live. Follow all personnel safety guidelines outlined in the section titled **Safety**.

NOTICE

Risk of unit damage if laid horizontally.

Starting the unit immediately after it has been lying down may cause permanent damage to the compressor. If the unit has been laid down (e.g., during transport or assembly), allow at least 1 hour before powering it on.

All electrical work must comply with the latest IEE regulations or local codes of practice, as applicable.

The heat pump installation must adhere to EMC Directive 2014/30/EU.

Always disconnect the mains power supply before removing any access panels from the heat pump.

The power supply to the heat pump must include the following protective devices:

- Fuses or motor-type circuit breakers (aM Fuse or MCB type C), rated as specified in the data sheet. HRC fuses are recommended for use with fuses.
- An isolator that disconnects all poles must be installed within 2 meters of the heat pump and in clear line of sight. This isolator should have a minimum air gap of 3mm when switched off and be positioned out of children's reach.
- The heat pump must be properly earthed/grounded and equipped with a dedicated RCD earth leakage protection device, which protects only the heat pump, in line with the ratings specified in the data sheet.

To avoid voiding the warranty, the following operating limits must not be exceeded:

Voltage	Minimum	Maximum
Single phase heat pumps	207 V	253 V
Three phase heat pumps	360 V	440 V
Cycle frequency (50Hz)	47.5 Hz	52.5 Hz

The available voltage at the heat pump must remain above the minimum required values, even when the compressor starts.

Installation

Power connection



To access the heat pump connection terminals, remove the lower side access panel and the terminal box cover as illustrated in the diagram below.

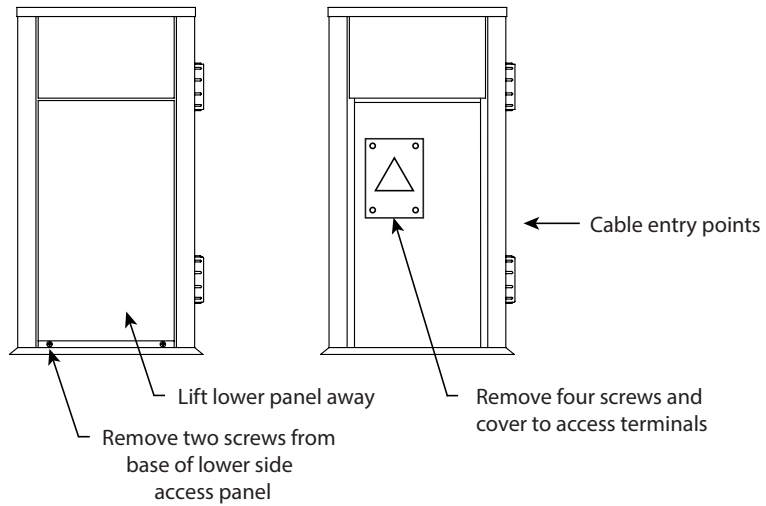

Supply cable should be connected in accordance to relevant diagram below.

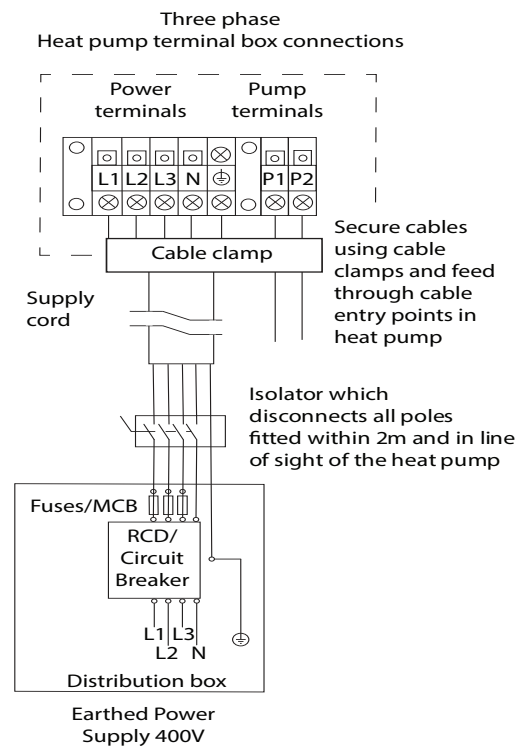
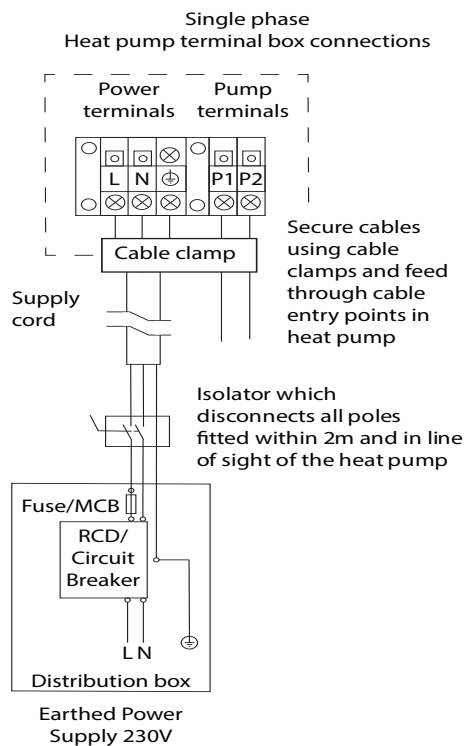

Installation

Pool water filter pump synchronisation terminals: P1 and P2



These terminals should not be used for installations where the circulation/filter pump runs continuously.

For installations where an external timeclock controls the filter pump, and the same pump also provides water flow to the heat pump, the heat pump can override the timeclock's off periods to ensure the pool water is heated or cooled. To activate this setting, please contact your installer (with P0 set to 2, the following applies).

When installed in parallel with the timeclock, the filter pump will run either during the timeclock's scheduled filtration periods or when the heat pump's sampling feature overrides the timeclock for 3 minutes to circulate water and measure the pool water temperature. The default sampling interval is 1 hour.

If during sampling, the pool water temperature differs by more than 1°C from the set temperature, the heat pump will continue running the filter pump to heat or cool the water. If the measured temperature is within 1°C of the set point, the filter pump will turn off until the next sampling period or the timeclock turns it back on.

If the pool water filter pump is running but the heat pump is not actively heating or cooling, the heat pump will sample the water temperature once per hour and activate if needed. However, the heat pump will not respond to heating or cooling demands until the sampling timer has elapsed.

This feature helps reduce filter pump run time and minimize energy consumption.

If the filter pump is later set to run continuously, it is recommended to deactivate the sampling function so the heat pump can immediately respond to heating or cooling demands.

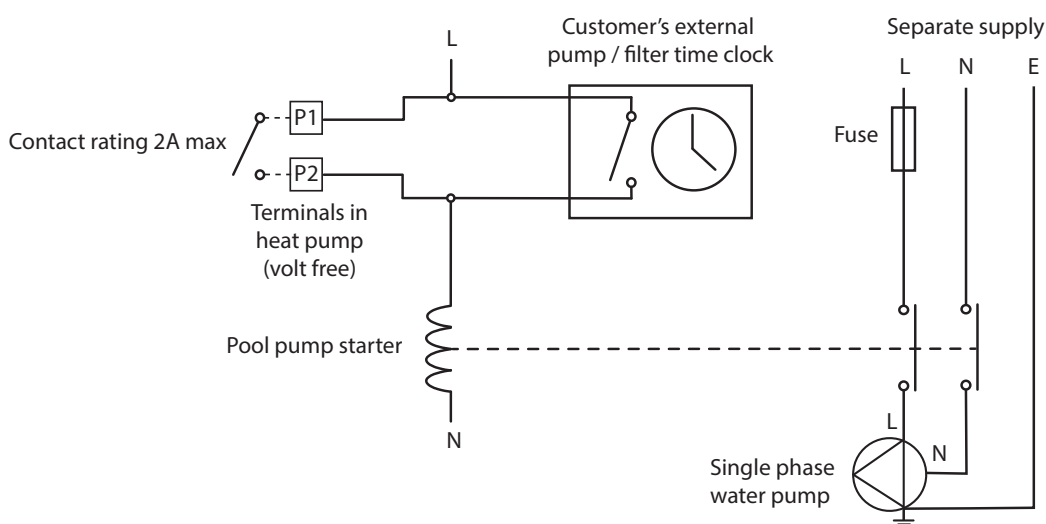



INFO



The installer will need to adjust parameter P0 when using the pool water filter pump synchronisation feature (see next page for P0 setting process).





Installation

For setting P0 the following process applies.

Press  for three seconds to unlock the screen.

To access the parameter list press and hold both  and  for five seconds.

Parameter P0 should now be visible but, if not, press either  or  to scroll through the parameter list to reach P0.

Press  and the value in P0 should flash, then press either  or  to select the desired value and press  to save the new setting.

The heat pump will leave the parameter list after thirty seconds.

NOTICE

Under no circumstances should any parameters, other than P0, be adjusted, as this could significantly affect the heat pump's performance and void the warranty.

If operating the heat pump in ambient air temperatures of 2°C or lower, ensure continuous water flow through the heat pump to prevent frost damage.

- **P0 set to 0:** Terminals P1 and P2 will close whenever the heat pump is turned on.
- **P0 set to 1:** Terminals P1 and P2 will close whenever the heat pump has a heating or cooling demand.
- **P0 set to 2:** Terminals P1 and P2 will close during the sampling period. If a heating or cooling demand occurs during this period, they will remain closed until the demand is met, at which point terminals P1 and P2 will open.

Remote on ~ off terminals 5 and 6

For installations requiring a remote on/off function, an external switch can be used to override the main on/off switch on the heat pump control panel.

The heat pump comes with a link fitted between terminals 5 and 6 in the terminal box. This link should be removed and replaced with an external switching device, as shown in the diagram below.

When the external switch contacts are closed, the heat pump will power on and remain operational until the external switch contacts are opened.

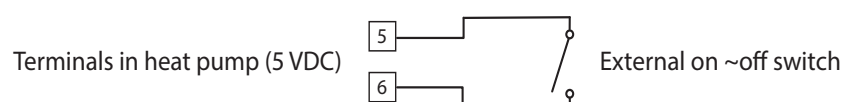

Installation

Initial checks



NOTICE

Ensure the following checks are completed and procedures followed before operating the heat pump.

Pre-Operation Checklist for the Heat Pump:

1. **Power Isolation:** Double-check that the mains power supply is isolated before inspecting the heat pump wiring.
2. **Electrical Wiring:** Ensure the electrical wiring conforms to the wiring diagram, and the heat pump is properly grounded.
3. **Ventilation:** Verify that the fan, air inlet, and outlet are unobstructed.
4. **Water Flow:** Ensure that pool water is flowing through the heat pump before turning it on. Always turn on the pool circulation/filter pump before starting the heat pump, and turn off the heat pump before shutting down the circulation/filter pump.
5. **Water Leaks:** Check for any water leaks before powering on the heat pump.
6. **Power-Up Sequence:** Once connected to the mains supply and switched on, the control panel will display various firmware codes. This is normal, and the heat pump will return to a locked status once the startup cycle completes.
7. **Temperature Settings:** To avoid overheating or overcooling the pool water, check the set temperature on the control panel and adjust if necessary.
8. **Time Delays:** The heat pump includes built-in time delays to protect components:
 - The fan will run for 1 minute before the compressor starts.
 - After the heating or cooling process stops, or when the heat pump is turned off, the fan will continue running for 1 minute.
9. **Monitoring:** After turning on the heat pump, or when heating/cooling begins, check for any protection or error codes on the control panel and listen for abnormal noises.
10. **Remote Control Panel Test:** If a remote control panel is installed, perform the following test to verify correct operation:
 - Set the temperature on the remote panel to 2°C above the current pool water temperature.
 - If pump synchronization is not active, the heat pump should start heating immediately.
 - If pump synchronization is active, heating will begin during the next sampling period.

Operation

Heat pump control panel

en





Symbol	Designation	Function
	On ~ Off	1. Heat Pump On ~ Off 2. Wi-Fi Setting
	Lock ~ Unlock Heat ~ Cool ~ Auto Mode	1. Lock ~ Unlock Screen 2. Heating Mode (18°C to 40°C) 3. Cooling Mode (12°C to 30°C) 4. Auto Mode (12°C to 40°C)
	Turbo ~ Perfect ~ Silence Mode	1. Turbo Mode 2. Perfect Mode 3. Silence Mode
	Up ~ Down	Temperature Setting
	Heating Mode	
	Cooling Mode	
	Auto Mode	
	1. Input Power 2. Running Speed Percentage	
	Wi-Fi Connection	
	Inlet Water Temperature / Actual Pool Water Temperature	
	Outlet Water Temperature	



Operation



Heat pump control panel

Screen lock

If there is no activity for more than 30 seconds, the screen will automatically lock,  will illuminate, and the other buttons and indicators will dim.



Press and hold  for three seconds to unlock the screen. All buttons and indicators will then illuminate.

Press and hold  for three seconds to lock the screen,  will remain illuminated and all the other buttons and indicators will dim.



If the screen is locked with the Wi-Fi connected then both  and  will be illuminated, while all other buttons and indicators will be dim..

Only  functions when the screen is locked; all other buttons are disabled.

Power on



Press and hold  for three seconds to unlock the screen, then press  to power on the heat pump.

Temperature setting

Press  or  to display and adjust the required set temperature.

Heat, cool and auto mode selection

Press  to switch between heating, cooling and auto modes.

Mode	Symbol	Water temperature setting range
Heating Mode		18°C to 40°C
Cooling Mode		12°C to 30°C
Auto Mode		12°C to 40°C

In Auto mode, cooling will automatically start if the water inlet temperature exceeds the set point.
Heating will automatically start if the water inlet temperature drops below the set point.

Operation



Heat pump control panel

Turbo, perfect and silence mode selection

In heating mode, press  to switch between turbo, perfect and silence mode. Cooling or Auto modes only support Turbo and Perfect modes.



Operating frequency

To switch between real-time input power and compressor speed percentage display, press the designated button. Real-time input power is displayed by default.

Press and hold both  and  for five seconds to switch between real-time input power and compressor speed percentage display.

Wi-Fi connectivity

To set up Wi-Fi connectivity, refer to the section titled **Setting up the App**.



To clear any existing Wi-Fi connections, press and hold  for 10 seconds until the  flashes slowly. Then, turn off the heat pump using the mains isolator. Power the heat pump back on using the mains isolator, and the existing Wi-Fi connection should be cleared.

Defrost

Automatic Defrost: During automatic defrosting,  will flash. Once the defrost cycle is complete, the heat pump will return to the previously selected mode.

Manual Defrost: To initiate forced defrost mode, the compressor must have been running in heating mode for at least 10 minutes.

The interval between forced defrosts should be at least 35 minutes.

Press and hold both  and  for five seconds to start the forced defrost.  will flash during the defrost process.

Do not use any other means to accelerate the defrosting process or to clean the evaporator.

INFO

During a normal defrost cycle, the heat pump may release significant amounts of vapour or mist into the air.

After a power cut, the heat pump may restart automatically when power is restored, as it is equipped with a power-down memory feature.

Electrical storms can damage the electronic circuits in the heat pump. It is recommended to isolate the heat pump from the mains power supply if a storm is expected.

Operation

Remote control panel



Symbol	Designation	Function
	On ~ Off	1. Heat Pump On ~ Off 2. Wi-Fi Setting
	Heat ~ Cool ~ Auto Mode	1. Heating Mode (18°C to 40°C) 2. Cooling Mode (12°C to 30°C) 3. Auto Mode (12°C to 40°C)
	Turbo ~ Perfect ~ Silence Mode	1. Turbo Mode 2. Perfect Mode 3. Silence Mode
	Up ~ Down	Temperature Setting
	Timer	
	Heating Mode	
	Cooling Mode	
	Auto Mode	
	1. Input Power 2. Running Speed Percentage	
	Wi-Fi Connection	
	Inlet Water Temperature / Actual Pool Water Temperature	
	Outlet Water Temperature	

Operation

Remote control panel

Screen lock



If there is no operation for more than 30 seconds, the screen will automatically lock and the buttons and indicators will dim.

Press  to unlock the heat pump.



Power on

Press  to power on the heat pump.

Temperature setting



Press  or  to display and adjust the required set temperature.

Temperature display units

Press and hold both  and  for five seconds to switch between °C and °F display.

Heat, cool and auto mode selection

Press  to switch between heating, cooling and auto modes.

Mode	Symbol	Water temperature setting range
Heating Mode		18°C to 40°C
Cooling Mode		12°C to 30°C
Auto Mode		12°C to 40°C

In Auto mode, cooling will automatically start if the water inlet temperature exceeds the set point, and heating will automatically start if the water inlet temperature falls below the set point.

Turbo, Perfect, and Silence mode selection

In heating mode, press  to switch between Turbo, Perfect, and Silence modes. Cooling and Auto modes only support Turbo and Perfect modes.

Wi-Fi connectivity

To set up Wi-Fi connectivity, refer to the section titled **Setting up the App**.

Operation

Remote control panel



Calibrate the timer

Press and hold  for five seconds to access the timer calibration function, **88.88** will flash.



Press  or  to adjust the time.

Press  to exit the calibration function.



Timer setting

Press and hold  for ten seconds to access the timer setting function,  will be illuminated and **ON** flashes.

Press  to switch between single timer **ON** or cycle timer **1-ON**.

Press  or  to adjust the required heat pump on time then press  to confirm the setting and enter the timer off setting, **OFF** flashes.

Press  to switch between single timer **OFF** or cycle timer **2-OFF**.

Press  or  to adjust the required heat pump off time then press  twice to confirm the setting and exit the timer setting function.

Single timer will only perform the set function once at the set times. Cycle timer will repeat the function every day at the set times.

Cancel the timer setting

Press and hold  for ten seconds to access the timer setting function.

Press  to cancel the timer setting.

Operation



Remote control panel

Defrost

Automatic Defrost: During automatic defrost,  will flash. Once the defrost cycle is complete, the heat pump will return to the previously selected mode.

Manual Defrost: To initiate forced defrost mode, the compressor must have been running in heating mode for at least 10 minutes.

The interval between forced defrosts should be at least 35 minutes.

Press and hold both  and  for five seconds to start the forced defrost.  will flash during the defrost process.

Do not use any other means to accelerate the defrosting process or to clean the evaporator.

INFO

During a normal defrost cycle, the heat pump may release significant amounts of vapour or mist into the air.

After a power cut, the heat pump may restart automatically when power is restored due to its power-down memory feature.

Electrical storms can damage the electronic circuits in the heat pump. It is recommended to isolate the heat pump from the mains power supply if a storm is expected.

Set up

Setting up the APP

INFO

Download the Pooltherm App and register the account via e-mail.



Android please download from



iOS please download from

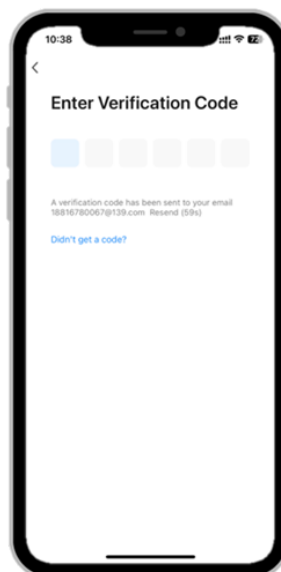
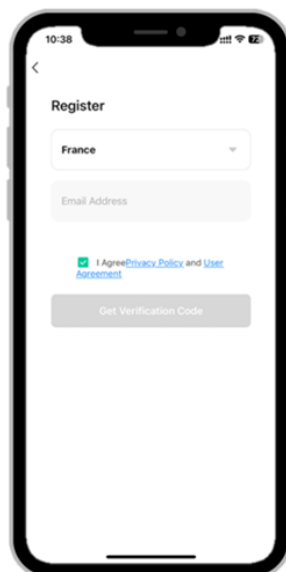
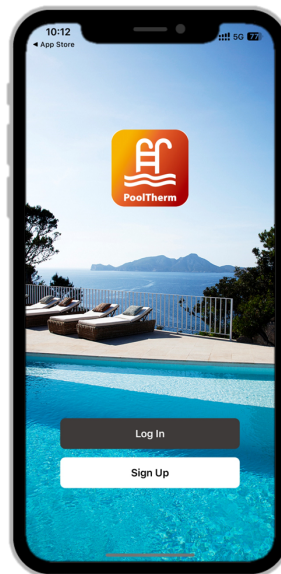

Set up: Pairing the App automatically

Set up

Pairing the App automatically

en

Ensure you have your SSID and Password available before attempting the pairing function. Please make sure you are connected to the Wi-Fi.

Put the heat pump into pairing mode as follows:

Stage 1: Press  for three seconds to unlock the screen.

Stage 2: Press  for three seconds, then release it. After hearing the beep enter the Wi-Fi code.

During the connection process the  indicator flashes rapidly and will stop flashing when the App successfully connects to the Wi-Fi.

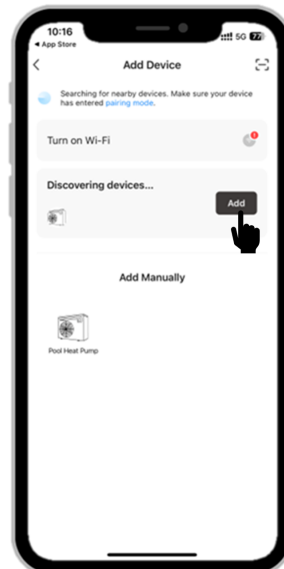
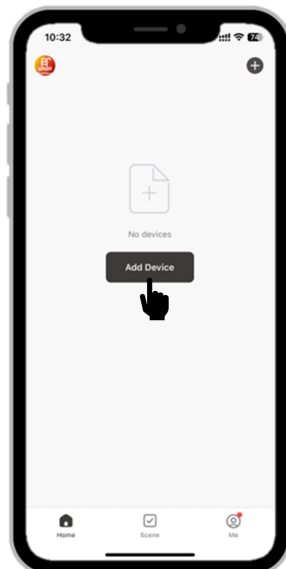

Set up

Pairing the App automatically

INFO

If the device fails to pair with the app, attempt manual pairing. This process is described in the section titled **Pairing the App Manually**.

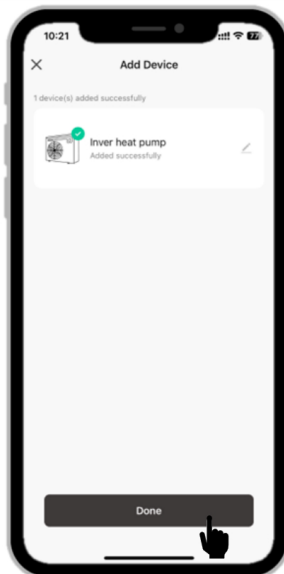
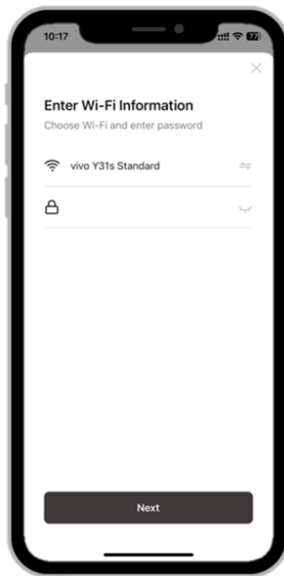

Set up

Pairing the App manually

en

Ensure you have your SSID and password ready before attempting the pairing function, and make sure you are connected to Wi-Fi.

To put the heat pump into pairing mode, follow these steps:

Stage 1 : Press  for three seconds to unlock the screen.

Stage 2 : Press  for three seconds, then release it. After hearing the beep, enter the Wi-Fi code.

During the connection process, the  indicator will flash rapidly and stop flashing once the app successfully connects to the Wi-Fi.

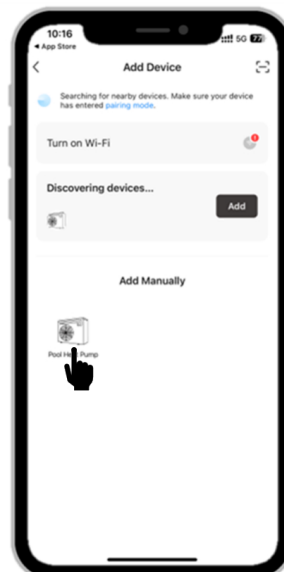
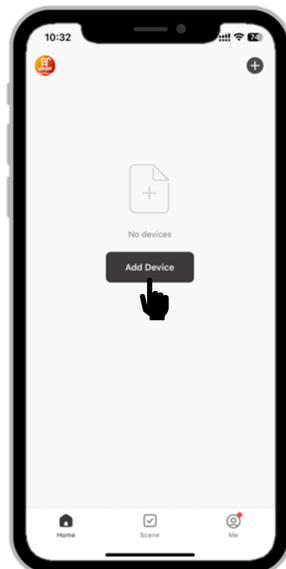

Set up

Pairing the App manually

INFO

Before pressing 'Confirm', ensure the  indicator is flashing rapidly. If it is not, repeat Stages 1 and 2 on the heat pump control panel until the indicator flashes rapidly, then press 'Confirm'.

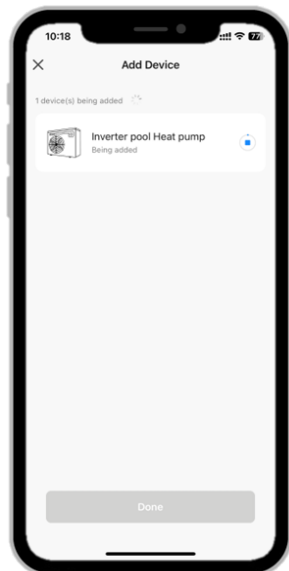
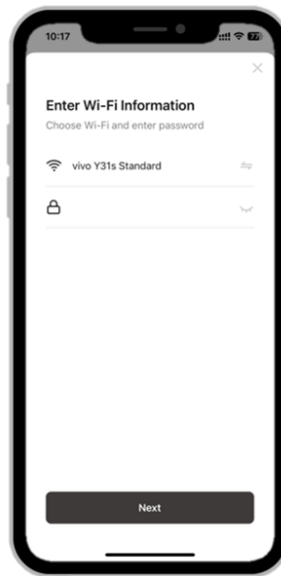
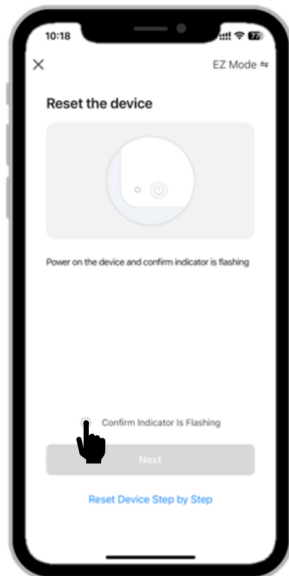

Set up

App screen

INFO

The home page of the app is shown below, displaying the current operating modes and parameters. Access to other pages is available through the home page as needed.



Maintenance

General maintenance instructions



DANGER

Risk of electric shock and injury due to moving parts.

Working with the power supply switched on can result in serious injury. Follow the personnel requirements outlined in the section titled **Safety**.

Before performing any maintenance, ensure the unit is switched off and isolated from the mains power supply. Ensure all work is fully completed before reconnecting the heat pump to the mains power supply and switching it back on.



CAUTION

Release of substances hazardous to health.

Substances hazardous to health may be released when removing dust and other contaminants.



Avoid cleaning with compressed air.

Always wear a dust mask (filter class FFP2 or higher) when performing cleaning tasks.

To ensure optimal operation and a long service life, the unit must be properly maintained according to the specified guidelines. Regular maintenance activities are outlined in this section.

After completing maintenance, restart the unit to confirm normal functionality is restored. In addition to regular preventive maintenance, it is recommended that a refrigeration technician inspects the cooling circuit and electrical functions. This inspection must comply with national regulations for air conditioning system checks.

The following maintenance intervals must be observed:

Status	Maintenance interval
units in operation	monthly (see section titled Maintenance: General instructions)
units in storage	annually (see section titled Transportation, handling and storage)

CAUTION



Sharp edges:

The cabinet of the unit may have sharp edges that could cause cuts. Always wear protective gloves when opening the unit.



Very hot and very cold parts inside:

There may be extremely hot or cold components inside the unit that can cause burns. Switch off the unit at least half an hour before opening it.



Wear protective gloves when working inside the unit.

Maintenance

General instructions

The heat pump should be covered with the winterisation cover when not in use for long periods.

Clean the heat pump with household detergents or clean water. Never use petroleum based spirit, thinners or any similar type fuels.

Regularly check bolts, cables and connectors.

Regularly check the condensate drain hose for blockages and clear if required.

Keep the evaporator clean and free from blockages using a soft brush.

Care must be taken not to touch the evaporator fins with your hands as the edges are sharp and may cause injury.

Repair, servicing and disposal of redundant heat pumps must be carried out by authorised technicians.

It is illegal to allow refrigerant gases to escape into the air.

NOTICE

Anyone working on or accessing the heat pump's refrigeration circuit must hold a valid, current certificate issued by an industry-accredited assessment authority. This certificate confirms their competence in handling refrigerants safely, in accordance with an industry-recognised assessment specification (F-Gas registered).

Improper maintenance or operation may pose serious risks.

WARNING

Risk of injury due to refrigerant leak.

If a refrigerant leak is suspected, stop using or working on the heat pump immediately and contact the Dantherm Group UK Service Department.

Backwash

During a routine backwash, place the heat pump in standby mode or turn it off and wait for the fan to stop.

Isolate the heat pump from the pool water supply before performing the backwash.

After backwashing, reconnect the heat pump to the pool water supply and ensure water is flowing through the heat pump before taking it out of standby mode or switching it back on.

Maintenance

Heat pump malfunction

NOTICE

Refer to the sections titled **Protection Codes** and **Fault Codes** before initiating a service call. Do not attempt to change any internal control settings or parameters, as these have been factory calibrated to ensure optimal heat pump performance.

Any signs of abnormal operation should be reported to the installer immediately. If in doubt or if further advice is needed, contact the Dantherm Group UK Service Department on +44(0) 1621 856 611 (option 2), providing the heat pump model number and serial number.

Fault	Reason	Solution
Unresponsive controller.	Screen lock is active.	Unlock screen.
Heat pump does not run.	No power.	Wait until power is restored.
	Power is switched off.	Switch on the power.
	Fuse has blown.	Check and change the fuse.
	The breaker has tripped.	Check and reset the breaker.
Fan running, but poor water cooling ~ heating performance.	Heat ~ cool not working.	Check mode is correct.
	Evaporator fins blocked.	Remove the obstruction.
	Air inlet ~ outlet blocked.	Remove the obstruction.
	Compressor start delay protection.	Wait for three minute delay to time out.
Display normal, but no water heating performance.	Set temperature too low.	Raise desired set temperature.
	Compressor start delay protection.	Wait for three minute delay to time out.
Heat pump suddenly starts or stops running.	The heat pump may be performing a defrost. The fan stops and the heat indicator on the control panel will flash.	This is normal operation, and the heat pump will resume normal function once the defrost cycle is complete.
	If the set point temperature is reached, the heat pump will go into standby mode.	This is a normal operation.
	The App and remote have timer controlled on ~ off.	Check the App or remote control panel, if applicable.
Heat pump is venting white smoke.	The heat pump is performing a defrost cycle.	This is a normal operation.
Heat pump is leaking water from the base.	In heating mode, condensation will form on the evaporator and drain out of the heat pump base.	This is normal operation.
If the solutions above do not correct the fault, then please contact your installer or the Dantherm Group UK Service Department.		

Maintenance

Protection codes

NOTICE

These codes indicate that the heat pump has stopped running due to external factors. These codes do not indicate faults within the heat pump.

Display	Reason	Solution
E3	No water though the heat pump.	Check water circuit and pool water pump.
E4	Three phase sequence protection.	Qualified electrician to check the three phases are connected correctly.
E5	Supply voltage to heat pump is out of range.	Check the power supply.
E6	Excessive temperature difference between water inlet and outlet is caused by low water flow through the heat pump.	Check the water circuit and pool water pump.
Eb	Ambient air temperature is out of range, either below -20°C or above 43°C.	If located outside, then wait for the ambient conditions to improve (winterisation may be required). If located in a sheltered position, check for air recirculation.
Ed	Frost protection. The heat pump runs in heating mode for a period when in standby mode to prevent frost ~ ice build-up. This does not replace winterisation.	The heat pump will return to standby mode once the process is complete.

Maintenance

Fault codes

NOTICE

When the heat pump displays one of these fault codes, please contact your installer or the Dantherm Group UK Service Department for advice.

Display	Description of fault
E1	High pressure alarm.
E2	Low pressure alarm.
E7	Water outlet temperature out of range.
E8	High exhaust temperature alarm.
EA	Heat exchanger or evaporator over temperature alarm.
P0	Controller communications failure.
P1	Water inlet temperature sensor failure.
P2	Water outlet temperature sensor failure.
P3	Gas exhaust temperature sensor failure.
P4	Evaporator coil pipe temperature sensor failure.
P5	Gas return temperature sensor failure.
P6	Cooling coil pipe temperature sensor failure.
P7	Ambient temperature sensor failure.
P8	Cooling plate temperature sensor failure.
P9	Current sensor failure.
PA	Restart memory failure.
F1	Compressor driver module failure.
F2	PFC module failure.
F3	Compressor start failure.
F4	Compressor running failure.
F5	Inverter board over current protection.
F6	Inverter board overheat protection.
F7	Current protection.
F8	Cooling plate overheat protection.
F9	Fan motor failure.
Fb	Power filter plate no power protection.
FA	PFC module over current protection.

Annex
Technical data sheet: single phase heat pumps

Model	Units	10A	16A	22A	28A
PERFORMANCE CONDITIONS : Air 27°C / Water 27°C / RH 80%					
Heating capacity (Turbo)	kW	14.5	22.5	27	32.5
Heating capacity (Perfect)	kW	11.6	18	21.6	26
COP range (Perfect)		7.5 ~ 20.1	7.3 ~ 20.4	7.4 ~ 20.2	7.2 ~ 20
Average COP at 50% speed (Perfect)		14.8	15.2	15	14.7
PERFORMANCE CONDITIONS : Air 15°C / Water 26°C / RH 70%					
Heating capacity (Turbo)	kW	9.6	15	18.5	22.7
Heating capacity (Perfect)	kW	7.8	12	15	18.8
COP range (Perfect)		5.2 ~ 8.6	5.3 ~ 9.0	5.2 ~ 8.9	5.4 ~ 8.1
Average COP at 50% speed (Perfect)		7.4	7.7	7.6	7.2
PERFORMANCE CONDITIONS : Air 35°C / Water 28°C / RH 80%					
Cooling capacity	kW	6.7	11.9	13.5	15.4
TECHNICAL SPECIFICATIONS					
Operating air temperature	°C	-20°C to 43°C			
Water heating setting range	°C	18°C to 40°C			
Water cooling setting range	°C	12°C to 30°C			
Power supply		230V Single Phase 50 Hz			
Rated input power	kW	0.22 ~ 1.85	0.34 ~ 2.83	0.43 ~ 3.56	0.50 ~ 4.20
Rated input current	A	0.96 ~ 8.04	1.48 ~ 12.30	1.87 ~ 15.48	2.17 ~ 18.26
Maximum input current	A	12.5	18.5	20.5	24
Rated RCD type F	mA	30			
Rated fuse aM / MCB type C	A	16	25	25	32
Sound pressure level at 10m	dB(A)	16.4 ~ 24.8	18.8 ~ 28.5	18.8 ~ 29.2	19.6 ~ 30.2
Recommended water flow rate	m ³ /h	3 ~ 4	6 ~ 9	8 ~ 10	10 ~ 12
Water pressure drop	kPa	5	8	12	16
Maximum air flow	m ³ /h	4000	5600	6500	7000
Pool water connections		48.3mm or 50mm Female			
GENERAL DATA					
Net dimensions (wxdxh)	mm	946x427x660	1195x427x760	1071x536x953	1264x536x954
Packed dimensions (wxdxh)	mm	1015x450x815	1265x450x915	1142x560x1115	1340x560x1115
Net weight	kg	65	82	100	122
HERMETIC SYSTEM					
Refrigerant charge R32	kg	1.25	1.7	2.3	3
Refrigerant CO ₂ equivalent	ton	0.844	1.148	1.553	2.025
Minimum area requirement	m ²	13.3	24.6	45	76.6
Heat pump data and performance parameters are subject to modification without prior notice. Always refer to the nameplate. Global warming potential (GWP) of R32 is 675.					

Annex
Technical data sheet : three phase heat pumps

Model	Units	22B	28B	36B
PERFORMANCE CONDITIONS : Air 27°C / Water 27°C / RH 80%				
Heating capacity (turbo)	kW	27	32.5	40.5
Heating capacity (perfect)	kW	21.6	26	32.5
COP range (perfect)		7.3 ~ 20.1	7.3 ~ 19.7	7.3 ~ 20
Average COP at 50% speed (perfect)		14.9	14.6	14.7
PERFORMANCE CONDITIONS : Air 15°C / Water 26°C / RH 70%				
Heating capacity (turbo)	kW	18.5	22.7	29
Heating capacity (perfect)	kW	15	18.8	23.5
COP range (perfect)		5.3 ~ 8.6	5.3 ~ 8.2	5.2 ~ 8.0
Average COP at 50% speed (perfect)		7.4	7.2	7.1
PERFORMANCE CONDITIONS : Air 35°C / Water 28°C / RH 80%				
Cooling capacity	kW	13.5	15.4	20
TECHNICAL SPECIFICATIONS				
Operating air temperature	°C	-20°C to 43°C		
Water heating setting range	°C	18°C to 40°C		
Water cooling setting range	°C	12°C to 30°C		
Power supply		400V Three Phase 50 Hz		
Rated input power	kW	0.42 ~ 3.49	0.51 ~ 4.28	0.67 ~ 5.58
Rated input current	A	0.61 ~ 5.06	0.74 ~ 6.20	0.97 ~ 8.09
Maximum input current	A	8	9.4	12.5
Rated RCD type B	mA	30		
Rated fuse aM / MCB type C	A	10	16	16
Sound pressure level at 10m	dB(A)	19.0 ~ 29.4	19.7 ~ 30.4	19.9 ~ 30.5
Recommended water flow rate	m ³ /h	8 ~ 10	10 ~ 12	12 ~ 18
Water pressure drop	kPa	12	16	22
Maximum air flow	m ³ /h	6500	7000	8300
Pool water connections		48.3mm or 50mm Female		
GENERAL DATA				
Net dimensions (wxdxh)	mm	1071x536x953	1264x536x954	1364x536x954
Packed dimensions (wxdxh)	mm	1142x560x1115	1340x560x1115	1435x560x1115
Net weight	kg	111	132	147
HERMETIC SYSTEM				
Refrigerant charge R32	kg	2.4	3	3.6
Refrigerant CO ₂ equivalent	ton	1.62	2.025	2.43
Minimum area requirement	m ²	49	76.6	110.3
Heat pump data and performance parameters are subject to modification without prior notice. Always refer to the nameplate. Global warming potential (GWP) of R32 is 675.				

Annex

Electrolytic corrosion in swimming pools

en

Electrolytic corrosion occurs when dissimilar metals in contact with each other create a potential difference. When separated by a conductive substance, known as an electrolyte, this difference creates a small voltage that allows ions from one metal to pass to the other.

Similar to how a battery works, ions transfer from the most positive material to the more negative material. If this voltage exceeds 0.3 volts, the most positive material begins to degrade.

In swimming pools, this effect can occur as pool water serves as an ideal electrolyte, with components like the filtration system, heating elements, steps, and lights providing the dissimilar metals needed to complete the circuit. While these small voltages rarely pose a safety threat, they can cause premature equipment failure due to corrosion.

Like oxidation corrosion, electrolytic corrosion can lead to the rapid deterioration of metallic materials.

To prevent this type of corrosion, all metallic components in contact with pool water should be bonded together using 10mm² bonding cable. This includes non-electrical components such as metal filters, pump strainer boxes, heat exchangers, steps, and handrails.

It is highly recommended to retrofit bonding systems to existing swimming pools and spa pools that may not already be protected.

Annex

Winterisation procedure



DANGER

Risk of electric shock and injury due to moving parts.

Working with the power supply switched on can result in serious injury. Ensure you follow the personnel requirements outlined in the section titled **Safety**.

Before performing the winterisation procedure, ensure the unit is switched off and isolated from the mains power supply.

As the heat pump contains electrical and moving parts, it is strongly recommended that only a competent person carries out the winterisation procedure for your safety.

Drain Down Procedure for Frost Protection and Corrosion Prevention:

1. Isolate the mains power supply to the heat pump.
2. Remove external fuses from the heat pump mains supply and store them safely away from the heat pump to prevent accidental operation.
3. Ensure the water circulation pump is switched off.
4. Drain the water from the heat pump by disconnecting the pool water pipework to and from the heat pump.
5. Flush the heat pump's water circuit using clean tap water (do not use pool water). Use a hose connected to the water outlet connection and flush for at least ten minutes. If available, use a spray nozzle for more effective cleaning.
6. Allow any remaining water in the heat pump's water circuit to drain, then cover both the inlet and outlet water connections with plastic bags secured by elastic bands.
7. Uncover the heat pump connection terminals (refer to the section titled **Power Connection**) and spray the interior of the enclosure with a moisture-repellent aerosol, such as WD-40. Once done, reseal the enclosure.
8. If the heat pump is installed outdoors, protect it from the weather by covering it with a vented winterisation cover. Do not use plastic sheeting, as condensation can form inside the heat pump..

NOTICE

If the winterisation procedure is not adopted and frost or corrosion damage results then the warranty will become invalid.

Annex

Start up after winterisation procedure



DANGER

Risk of electric shock and injury due to moving parts.

Working with the power supply switched on can result in serious injury. Ensure you follow the personnel requirements outlined in the section titled **Safety**.

Before performing the start-up procedure, make sure the unit is switched off and the heat pump is isolated from the mains power supply.

As the heat pump contains electrical and moving parts, it is strongly recommended that only a competent person carries out the start-up procedure for your safety.

Heat Pump Start-Up Procedure After Winterisation:

1. Ensure all covers are properly fitted.
2. Remove the front grille and clean the heat pump's finned surfaces with a soft brush. Replace the front grille afterward.
3. Remove the plastic bags from the inlet and outlet water connections, and reconnect the pool water pipework to and from the heat pump.
4. Start the water circulation pump and allow it to run for at least 15 minutes to establish proper water flow and expel any air from the system.
5. Replace the external fuses in the heat pump mains supply.
6. Switch on the heat pump.
7. Verify that the set point temperature on the control panel is correct and adjust as necessary.
8. Check daily to ensure the pool water has the correct pH and chemical balance, as outlined in the table in the section titled **Warranty terms and conditions**.

Warranty

Terms and conditions

NOTICE

Warranty Exclusions:

The following exclusions apply to the warranty provided by Dantherm Group. No claims will be accepted if any of the following points or conditions are applicable:

- The heat pump has been installed in a manner not in accordance with the current procedures outlined by Dantherm Group.
- The heat pump has been serviced, worked on, or adjusted by anyone not authorised by Dantherm Group.
- The heat pump is incorrectly sized for the intended application.
- The water flow through the heat pump is outside the specified limits.

Acidity pH	pH	7.2 ~ 7.8
Total Alkalinity as CaCO ₃	ppm	80 ~ 120
Total Hardness as CaCO ₃	ppm	150 ~ 250
Total Dissolved Solids	ppm	1000
Maximum Salt Content	ppm	35000
Free Chlorine Range (Domestic)	ppm	1 ~ 2
Free Chlorine Range (Commercial)	ppm	3 ~ 6
Superchlorination	max	30 ppm for 24 hours
Bromine	ppm	2 ~ 5
Baquacil	ppm	25 ~ 50
Ozone	ppm	0.9 max
Maximum Copper Content	ppm	1
Aquamatic Ionic Purifier	ppm	2 max

- The water pH level and/or chemical balance are outside the specified limits.
The heat pump has sustained frost damage.
- The electrical supply is insufficient or incorrect in any way.
- The fan amperage and duct pressure are outside the specified limits.
- The airflow to or from the heat pump is outside the specified limits.

INFO

If in doubt or if advice is required, please contact the Dantherm Group UK Service Department by calling +44 (0) 1621 856 611 (option 2) or email service.uk@danthermgroup.com.

When making technical or service enquiries, please provide the heat pump model number and serial number. This will assist in accurate diagnosis and ensure service can be provided with minimal delay.

Reporting Security Vulnerabilities

Procedure

In accordance with the Product Security and Telecommunications Infrastructure (Security Requirements for Relevant Connectable Products) Regulations 2023, the link or QR code below allows for the reporting of security vulnerabilities identified in I-PAC PRO or Pooltherm products sold within the United Kingdom to Dantherm Group.

The link or QR code also provides information on when and how the vulnerability report will be acknowledged, how progress updates on the investigation will be communicated, and the relevant minimum security update periods for I-PAC PRO and Pooltherm products.

Link [hiips://info.danthermgroup.com/en-gb/vulnerability-report](https://info.danthermgroup.com/en-gb/vulnerability-report)



Spare parts and accessories ordering process

How to order

This section contains the general information needed when ordering accessories or spare parts.

Dantherm Group spare parts can be ordered at shop.dantherm.com.

Dantherm Group accessories can be ordered by contacting the Dantherm Group Sales team at sales.uk@danthermgroup.com.

Dantherm No.	Description
1009534	Wired remote control
1009535	Sealing strip

INFO

Not every item will be available individually if it is part of an assembly that forms a whole or if it is part of a complete component that has been purchased. Dantherm Group reserves the right to make this assessment.

Reservations

Dantherm Group further reserves the right to make any necessary changes to the construction and selection of components without notice, but will, as far as possible, keep the changed parts in stock.

DANTHERM GROUP



EU Declaration of Conformity

In accordance with the EU Low Voltage Directive 2014/35/EU, Annex IV

We, Dantherm Group Ltd
Unit 12, Galliford Road
Maldon CM9 4XD
United Kingdom

declare in sole responsibility that the following device

Product model / Product:	Inverter Pool Heat Pump	
Year of manufacture as of:	2024	
Product, batch, type or serial number:	I-PAC PRO 10A	1009277
	I-PAC PRO 16A	1009271
	I-PAC PRO 22A	1009272
	I-PAC PRO 22B	1009273
	I-PAC PRO 28A	1009274
	I-PAC PRO 28B	1009275
	I-PAC PRO 36B	1009276

has been developed, constructed and manufactured in compliance with the requirements of the European Directives:	2014/35/EU LVD
	2014/53/EU RED
	2014/30/EU EMC
	2011/65/EU RoHS

The object of the declaration described above is in conformity with the relevant Union harmonisation legislation.

The assessment is based on the following applied harmonised standards:	EN 60335-1:2012	(OJ L 457 – 21/12/2021)
	EN 60335-1:2012/AC:2014	
	EN 60335-1:2012/A11:2014	
	EN 60335-1:2012/A13:2017	
	EN 60335-1:2012/A1:2019	
	EN 60335-1:2012/A14:2019	
	EN 60335-1:2012/A2:2019	
	EN 60335-1:2012/A15:2021	
	EN IEC 63000:2018	(OJ L 155 - 18/05/2020)
	EN 300 328 V 2.2.2:2019	(OJ L 34 – 06/02/2020)

DANTHERM GROUP



Other applied technical standards and specifications:

EN 60335-1:2012+A16:2023
EN IEC 60335-2-40:2023+A11:2023
EN IEC 55014-1:2021
EN IEC 55014-2:2021
EN IEC 61000-3-2:2019+A1:2021
EN IEC 61000-3-3:2013+A1:2019+A2:2021
(for types 10A, 16A, 22A, 28A, 36B)
EN IEC 61000-3-11:2019
(for types 22B & for 28 B)
EN IEC 62311:2020
EN 62233:2008+AC:2008
EN 301 489-1 V 2.2.3 :2019
EN 301 489-17 V 3.2.4:2020

Place and date of issue:

Heinsberg, 22.11.2024

Jakob Bonde Jessen,
Dantherm Group
Group COO

Statement of compliance

DANTHERM GROUP

Statement of Compliance

We, **Dantherm Group Ltd**
Unit 12, Galliford Road
Maldon CM9 4XD
United Kingdom

hereby certify that the following Dantherm Group products:

Product model / Product:	Inverter Pool Heat Pump and PoolTherm App	
Product, batch, type or serial number:	I-PAC PRO 10A	1009277
	I-PAC PRO 16A	1009271
	I-PAC PRO 22A	1009272
	I-PAC PRO 22B	1009273
	I-PAC PRO 28A	1009274
	I-PAC PRO 28B	1009275
	I-PAC PRO 36B	1009276

Conforms with the deemed compliance conditions listed in Schedule 2 of
The Product Security and Telecommunications Infrastructure (Security Requirements for Relevant
Connectable Products) Regulations 2023 including the relevant parts of ETSI EN 306 645 V2.1.1 (2020-06)
as specified in the aforementioned schedule.

The minimum security update period for the I-PAC PRO products is zero month.

The minimum security update period for the PoolTherm App product aligns with the warranty period of the
product (5 years from the date of sale of the connected I-PAC PRO heat pump).

Place and date of issue: Heinsberg, 22.11.2024



Jakob Bonde Jessen,
Dantherm Group
Group COO

Notes:

Notes:

Notes:



Dantherm Group Ltd
Unit 12, Galliford Road
Maldon CM9 4XD
United Kingdom

www.danthermgroup.com

Visit shop.dantherm.com for information on availability of spare parts, lead times and ordering of parts.

Dantherm Sales team, product information and available accessories:
sales.uk@danthermgroup.com

Phone +44 (0)1621 856611

VAT: GB 223 5572 21

Dantherm Group accepts no responsibility for possible errors and changes (en)
Der tages forbehold for trykfejl og ændringer (da)
Irrtümer und Änderungen vorbehalten (de)
Dantherm Group n'assume aucune responsabilité pour erreurs et modifications éventuelles (fr)

